

BROADCAST NEWS

VOL. NO. 107 MARCH 1960



ALL NEW
4 1/2-inch Image Orthicon
TV Camera, TK-12

ANOTHER WAY RCA SERVES
BROADCASTERS THROUGH
ELECTRONICS



Now... **pick an effect**
from more than 150 possibilities!



Here's the ultimate in convenience for selection and presentation of program effects—the all new RCA Special Effects System. Key circuitry for each effect is contained in plug-in modules. Any ten effects may be pre-selected—simply plug ten modules into the control panel. Each module has illuminated symbol showing the effect it will produce. Slide an effect out—slide another in—it's just that easy. You get just the right effect to add that extra **SELL** to your programs and commercials.

SIMPLIFIED CONTROL—Push-buttons put effects selection at your fingertips. Push the buttons below the illuminated symbol and you are ready to go "on-air." Wipes and transitions are controlled by a standard fader lever for simple foolproof operation.

UNLIMITED VARIETY—The complete complement of 154 special effects includes wipes, split-screens, picture insets, block, wedge, circular and multiple frequency patterns. In addition, the system will accept a keying signal from any camera source to produce a limitless variety of effects—inset letters, drawings, trademarks; self-keyed video insets, and traveling mattes.

THE BEST EFFECTS WITH LESS EFFORT—Mix color and black-and-white. Enjoy exceptionally clean transitions... the most exciting effects ever conceived! And get them with the least amount of effort possible.

Ask your RCA Broadcast representative for complete information. Or write to RCA, Dept. BN-22, Building 15-1, Camden, N. J. In Canada: RCA VICTOR Company Ltd., Montreal



Tmk(s) ©

RADIO CORPORATION of AMERICA

BROADCAST AND TELEVISION EQUIPMENT, CAMDEN, N. J.

Vol. No. 107

March, 1960

BROADCAST NEWS

published by

RADIO CORPORATION OF AMERICA
BROADCAST & TELEVISION EQUIPMENT DIVISION
CAMDEN, NEW JERSEY

issued quarterly

PRICE *in U.S.A. - - - - \$4.00 for 4 issues*
outside U.S.A. - - - \$5.00 for 4 issues

C O N T E N T S

	Page
NEW HIGH EFFICIENCY 5 KW AM TRANSMITTER	8
TOUR THROUGH THE TV TAPE HEADWHEEL PLANT	14
TV TAPE SPLICER	19
HOW DESIGN OF TAPE TRANSPORT MECHANISM IMPROVES PERFORMANCE OF TV TAPE RECORDER	22
TV AUTOMATION AT WKRC	29
10 WATT TRANSISTOR MONITOR AMPLIFIER	45
NEW 1000 WATT FM TRANSMITTER	46
NEW 10 KW FM TRANSMITTER	48
MEASURING FM CARRIER DEVIATION	52
NEW VELOCITY MICROPHONE, TYPE BK-11A	54
ALL NEW MONOCHROME STUDIO CAMERA, TYPE TK-12	56
AUTOMATIC SENSITIVITY CONTROL	66

Copyright 1960, Radio Corporation of America, Broadcast & Television Equipment Division, Camden, N. J.

PRINTED
IN
U.S.A.

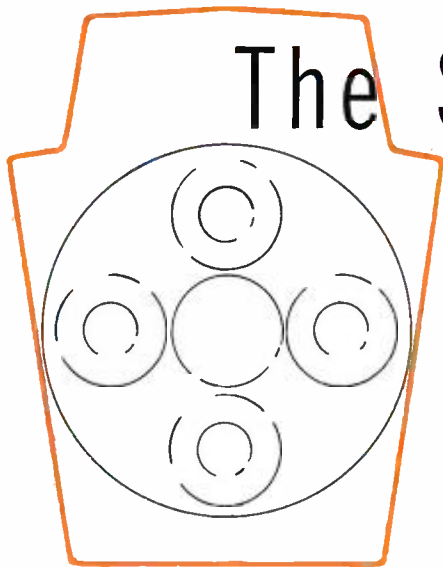

The Shape of Things

Here is the "shape" that means truly fine pictures . . . the shape of the all new black-and-white television camera, the RCA TK-12. This is the camera that gives you sparkle and impact in your commercials, whether live or taped. Your advertisers' products can be revealed clear and sharp, in all their fine detail . . . Shadings and colorings stand out, with brilliance and realism.

This completely new camera uses the large new RCA 4½-inch Image Orthicon tube. The 50% increase in image size results in the same degree of extra quality and detail you would expect from using a larger negative in advertising photography.

Here is the camera for top telecasters, for those with the reputation of providing their advertisers with the very best.

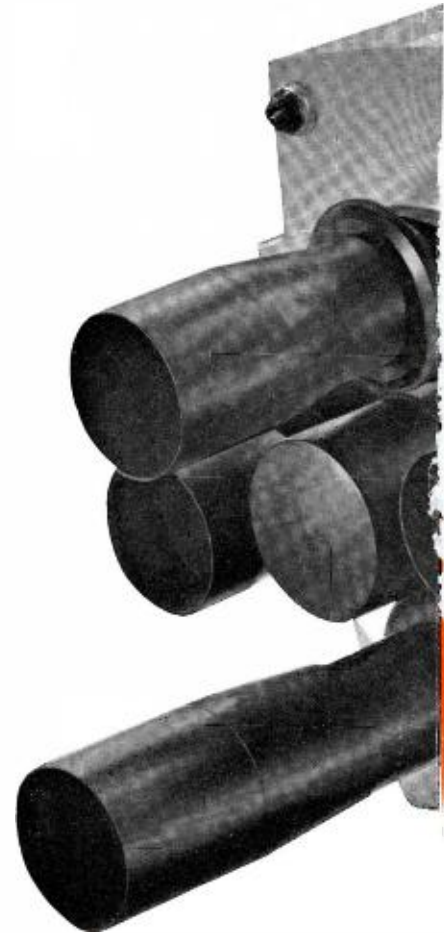

For the Finest Picture in Town!

**NEW MONOCHROME TV CAMERA—TK-12
WITH 4½-INCH IMAGE ORTHICON**

to Come

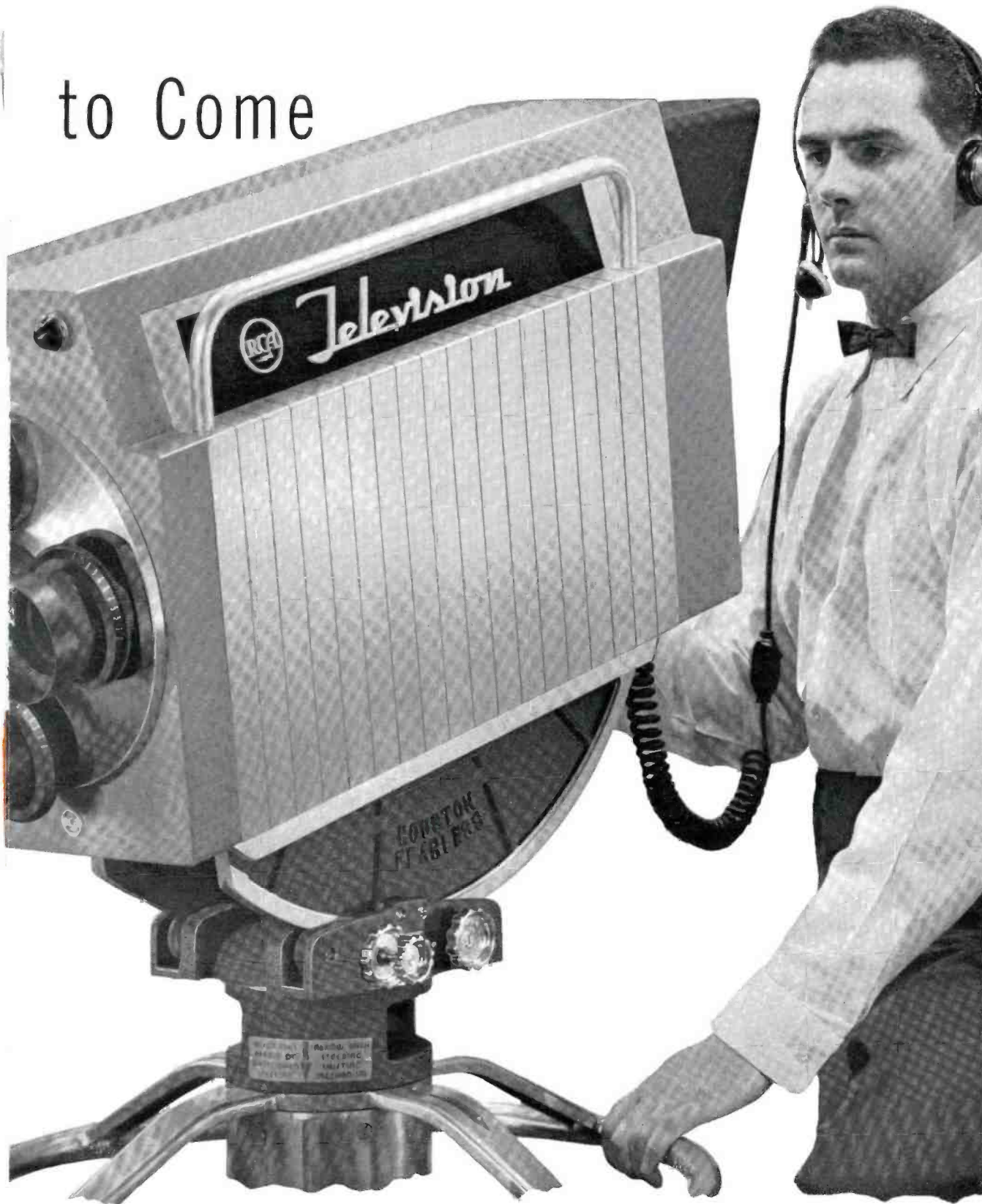

TM&S®

RADIO CORPORATION of AMERICA

BROADCAST AND TELEVISION EQUIPMENT • CAMDEN, N. J.

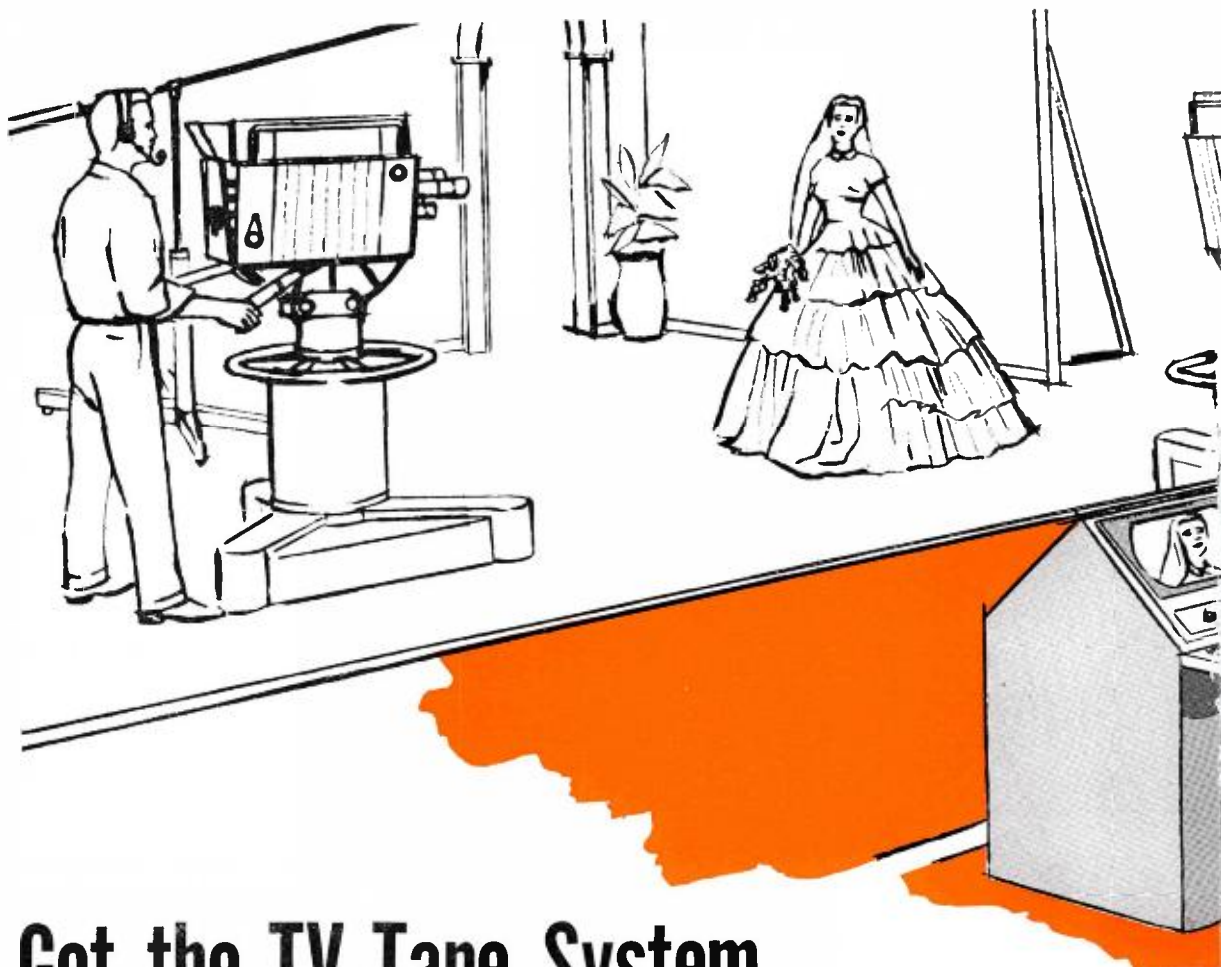

Get the TV Tape System with a **"MATCHED"** line of

RCA TV Tape Recorder • RCA Video Equipment • RCA TV Film Equipment •
RCA Audio Equipment • RCA Switching and Special Effects • RCA Film Recording
Equipment (Studio or Mobile—Monochrome or Color)

WHY NOT LET AN "OLD HAND" ASSEMBLE YOUR TV TAPE PRODUCTION PACKAGE?



Program Production Equipment

With an RCA TV Tape System you get equipment that is *designed* for incorporation into a complete package. You get everything you need from one reliable source of supply—from cameras to TV tape recorders, including audio, switching, and special effects. You obtain equipment with a background of experience that is without equal in the film and television industries. You get the finest pictures—both color and black-and-white . . . Why risk the chance of failure with unmatched equipment when you can get equipment from RCA that is matched—both electrically and mechanically—to work in a system.

Free brochure on RCA Customized TV Tape System is available. See your RCA Representative. Or Write to RCA Dept. BX-107, Building 15-1, Camden, N. J.



Tmk(s) ®

RADIO CORPORATION of AMERICA

BROADCAST AND TELEVISION EQUIPMENT • CAMDEN, N. J.

Now... Power Savings of

—through Unique Circuit



NEW BTA-5T 5 KW AM TRANSMITTER

How It Works: The increase in efficiency in the BTA-5T Transmitter is achieved by reshaping the modulated amplifier plate current pulse to reduce the power loss in the power amplifier tube during the conduction interval. A harmonic trap in the cathode circuit squares up the wave shape of the grid driving voltage, and another trap in the plate circuit further shapes the plate current pulse. Consequently, when the tube begins to conduct current, the power loss in the tube plate circuit is low and remains so throughout the cycle.

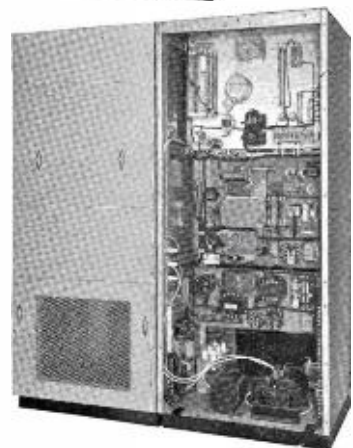

15,000 KW Hours per Yr.!

ANOTHER WAY
RCA SERVES
BROADCASTERS
THROUGH
ELECTRONICS

permitting 90% Plate Efficiency

NEW HIGH-PERFORMANCE 5 KW AM TRANSMITTER

This new transmitter incorporates the only significant development in Class "C" power amplifier design in 20 years. A new circuit provides a plate efficiency of 90%.

With continuous operation, savings of approximately 15,000 kilowatt hours per year are realized. Only 1 PA tube is needed.

Other improvements, including all silicon rectifiers and improved protective circuits, enhance performance and extend operating life.

Functional styling provides a choice of red or grey doors to suit station decor and add a harmonious note.



Some of the fine features of the New BTA-5T

1. FEWER TUBES—Fewer tubes—a total of twelve—save on replacement cost. Only one 5762 PA Tube for lower operating cost.

2. QUIET-OPERATING BLOWER—Very low plate dissipation in the output stages reduces heat within the transmitter, and also permits use of a slow-speed blower for quiet operation.

3. SILICON RECTIFIERS—All silicon hermetically sealed rectifiers of proven reliability are ideal for remote control.

4. OVERLOAD PROTECTION—Complete overload protection is provided for all circuits. All line breakers carry

an instantaneous over-current protection, while main breakers retain instantaneous and thermal protection. Remaining circuits are protected by fast-acting overload relays with provision for external indicators.

5. REMOTE CONTROL PROVISION—Built-in provision is made for *remote control* and conversion to Conelrad, power cut-back and a carrier off monitor.

6. FCC OK—Meets all new FCC Spurious Emission requirements.

7. SPACE SAVING—New style cabinets offer excellent accessibility to all components and allow a great saving in floor space.

Your RCA Broadcast Representative will gladly provide further particulars about this new transmitter. Or write to RCA, Dept. BN-107, Building 15-1, Camden, N. J. In Canada: RCA VICTOR Company Limited, Montreal.



RADIO CORPORATION of AMERICA

BROADCAST AND TELEVISION EQUIPMENT • CAMDEN, N. J.

NEW HIGH-EFFICIENCY 5-KW AM TRANSMITTER

Unique Class C Amplifier Operates With 90 Percent Efficiency

by I. R. SKARBEK, Broadcast Transmitter Engineering



FIG. 1. Easy access to all tubes is made through two interlocked front doors of the BTA-5T Transmitter. The PA, modulator, and silicon rectifiers are in the cabinet on the right, and the exciter, driver and control equipment is on the left. The attractively styled cabinets are available with red or gray doors.

This new 5-kw AM transmitter, type BTA-5T, incorporates the only worthwhile development in class "C" power amplifier design in 20 years. The newly-designed PA circuit operates with a plate efficiency of 90 percent. This represents an improvement of 20 percent over normal class "C" operation. As a direct result power savings of approximately 15,000 kilowatt hours per year can be realized.

Basically, the new transmitter uses the design proved in the BTA-5R/5R1.¹ However, using the recently-developed high-efficiency circuit, only one PA tube is needed. Other circuit innovations (such as silicon rectifiers and improved protection) have been made to improve performance and to extend operating life.

Principle of Operation

The high-efficiency plate-modulated power amplifier uses a single tube to deliver the nominal 5 kw with 5.5 kw power output capability at 90 to 92 percent plate power conversion. Referring to the simplified schematic (Fig. 5), the circuit arrangement is very similar to a conventional class "C" amplifier except for presence of two resonators L_1, C_1 and L_2, C_2 . In fact, the new high-efficiency stage behaves so much like the conventional class "C" stage that with the resonator shorted, or mis-tuned, the PA tube returns from the high-efficiency to the conventional class "C" operation. This characteristic, as will be shown later, is very useful in the initial tune-up of the transmitter. For the moment it will be helpful in making a detailed comparison.

In both systems the angle of the tube current conduction is restricted to that portion of the cycle wherein the instantaneous plate current is high and the instantaneous plate voltage low, corresponding to a low anode dissipation at a relatively high-power output. In the class "C" operation, however, the waveform is sinusoidal and is sub-

¹ "New 5000-Watt AM Transmitter", by J. Novik and I. R. Skarbek, *Broadcast News*, Vol. 103, March, 1959.

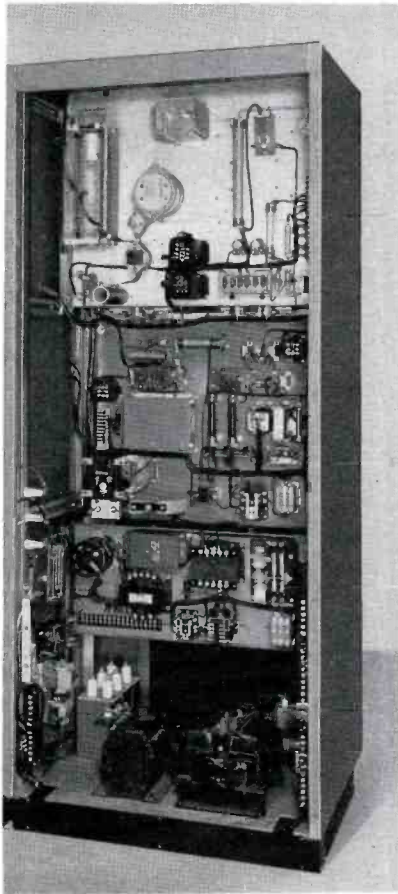

FIG. 2. This is the rear of the BTA-5T. Complete access to all components is easily made through the removable interlocked panels.

stantially rounded off. Therefore, a large portion of the power is lost in the anode, resulting in an average efficiency of about 70 percent. The new system provides corrective means for maintaining a flat waveform near the peak, resulting in 90 percent average plate efficiency.

The waveshaping is done by two LC parallel resonant circuits, one located in the plate and the other in the cathode circuit of the power amplifier tube. Both resonators are adjusted to resonate at the third harmonic of the carrier frequency.

When the amplifier tube is driven, the harmonic component of the grid input power sets up and maintains circulating current within each resonator. Since the resonator is designed to store high KVA, the total voltage supply at the plate is composed of the usual d-c plate supply and the superimposed oscillatory potential equal to the voltage build-up across the resonator. This oscillatory voltage, being at the third harmonic, vectorially adds twice to, and

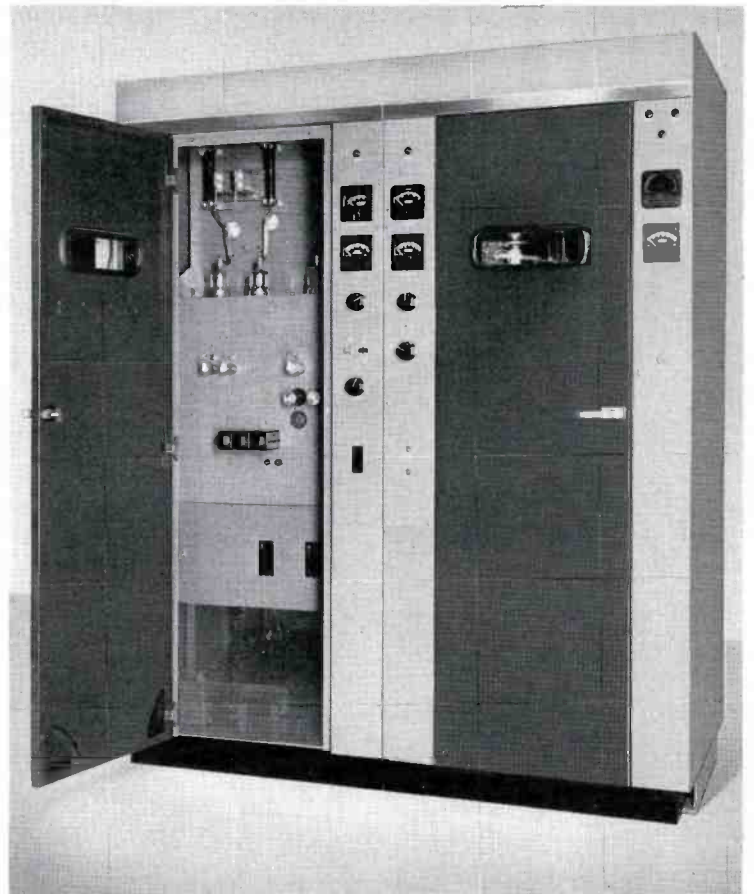

FIG. 3. The exciter and IPA stages are shown here. Note the three crystal sockets on the exciter chassis, and the easy to reach tubes.

TABLE I — EFFICIENCY COMPARISONS

		Conventional Class C BTA-5R	High Efficiency Class C BTA-5T
Power Amplifier (Carrier)			
Power Output	kw	5.0	5.0
Number of Tubes (RCA 5762)		2	1
Inst. Plate Current (calculated)*	Amps.	5.6	3.5
Inst. Grid Current (calculated)	Amps.	2.7	1.8
Peak Cathode Emission	Amps.	8.3	5.3
Plate Dissipation	kw	1.5	.57
Filament Power	kw	.74	.37
Plate Efficiency	%	76	90
Modulator & Power Ampl. (100% Mod.)			
PA Plate Dissipation	kw	2.25	.85
Modulator Plate Dissipation	kw	2.0	1.7
Overall Input	kw	13.3	11.2
Overall Efficiency	%	56.4	67
Transmitter Power Input (.95 P.F.)			
Carrier	kw	11.6	10.0
Average Program	kw	12.7	11.0
Input Power/Yr. Saving	kwh	—	15000

* The high efficiency calculation is based on a rectangular waveform, where the peak efficiency is equal to the average efficiency, i.e., V_p/E_p . The average power value is proportional to the angle of tube conduction, so the plate input, plate output, and the grid dissipation is: $i_p E_p K$; $i_p V_p K$ and $i_g (V_g - E_g) K$ respectively (where K is the duty cycle or $1/3$ for 120 degrees of tube conduction). The actual value given in Table I takes into account the correction factor determined experimentally.



FIG. 4. The author is shown adjusting the new PA stage. Only one 5762 tube is used for high efficiency operation. The coil, shown on the right is the third harmonic coil used in the plate circuit of the PA to increase efficiency by shaping the plate waveform

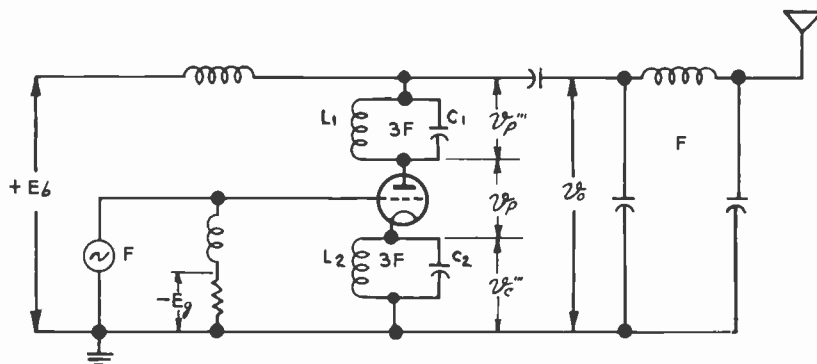

FIG. 5. This is a simplified schematic of the PA stage showing the location of the third harmonic coils.

subtracts once from the fundamental, thus producing a flat top waveform (see Fig. 7A). When the cathode resonator is adjusted to resonate at the third harmonic, the instantaneous grid-to-cathode potential modifies the cathode emission to approximate a rectangular pulse (see Fig. 7B).

Improved Efficiency

In the BTA-5T transmitter, adjustment of the plate resonator improves the efficiency by 6 to 8 percent. Subsequent adjustment of the cathode resonator improves the efficiency by an average total of 20 percent above conventional class "C" operation.

Improved Tube Performance

The energy stored within the resonator modifies the instantaneous current voltage waveform of the conventional class "C" amplifier to reduce its amplitude and

broaden the top. For the same power output, this means not only reduction in the plate dissipation, but also considerable reduction in peak-plate to plate-peak grid current and operation at a much lower cathode emission (see Table I). As the result of the high-efficiency operation, the BTA-5T transmitter employs only one PA tube, an RCA type 5762. It is worthy to note that plate dissipation in the new system is comparable to the filament power consumption of the old.

Improved Stability and Tuning

The third important feature in favor of the new transmitter is: simplicity of the initial tune-up and stability of operation. Upon mistuning the harmonic resonator, the PA tube returns from the high-efficiency to the conventional class "C" operation. Except for the loss in the efficiency of the PA, the circuit neutralization, tank tuning,

the stage loading remains the same for both types of operation.

Applying the above procedure in reverse, the initial tune-up consists of the resonator adjustment to obtain the maximum power output as indicated by the line or the antenna current ammeter. The plate resonator chiefly contributes toward the power output, while the cathode resonator in addition to increasing power output to some extent increases the power input.

With the system properly in operation, tuning of the output tank is similar to tuning of the conventional class "C" amplifier, except the tuning is broader. On either side of the tuning-dip the plate current rise is more gradual, the power output slightly rising on one side and falling on the other side. This self-adjusting property would provide additional stability in the case of accidental mistuning or mistuning due to a reactive load.

Overall Performance

Both the conventional and the high efficiency system were compared using essentially the same transmitter circuit with identical components. Each offered similar performance insofar as modulation capability, audio distortion, carrier shift and noise level are concerned (see Fig. 8). Tests were carried out over the broadcast frequency range, using a number of tubes of different socket life. Therefore, the high-efficiency class "C" operation data listed in Table I may be considered as typical for this power level and frequency of operation.²

Longer Tube Life

In order to determine what effects the high efficiency circuit would have upon 5762 tube life, tubes with known expectancy life characteristics were obtained and placed for service in a transmitter operating at maximum conditions with greater than average modulation applied for extended periods of time. The tubes were then re-tested, opened, the parts measured, and examined for evidence of deterioration. It was found that the life expectancy of all the tubes examined to be as good or greater than the expected life of tubes operating under conventional class "C" service.

Compact and Convenient

The entire transmitter, except the plate transformer, is housed in two attractively styled cabinets (see Fig. 1). All meters, indicators, control switches and tuning controls are located on the front panels. Vertical center chassis are fastened between the

² Data on operation at other power levels is given by V. J. Tyler, *Marconi Review*, No. 130, Vol. XXI.

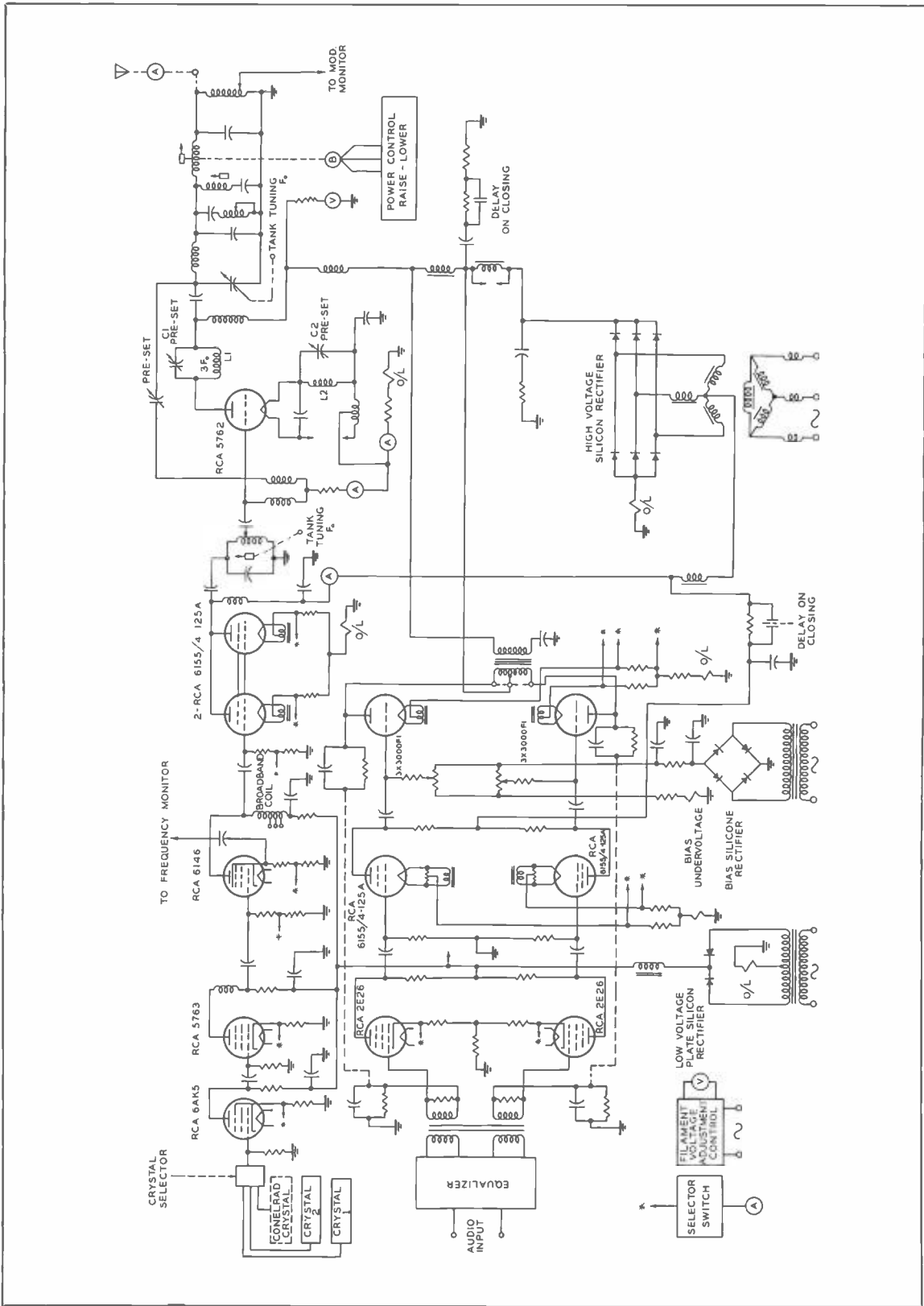

FIG. 6. The overall schematic of the BTA-5T is shown here. The new PA circuit resembles a conventional class "C" stage except for the addition of the plate and cathode L-C circuits for high efficiency operation. The silicon rectifiers are also shown.

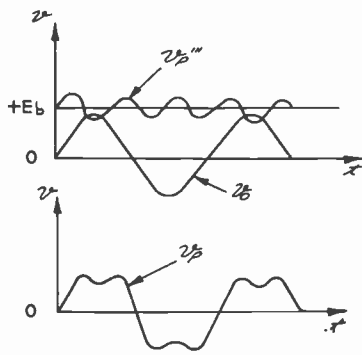

FIG. 7A. This is the harmonic addition of the plate voltage and the oscillatory voltage from the third harmonic L-C circuit. The resultant plate voltage waveform, below, resembles a square wave, and it is obvious the average level of plate voltage is higher.

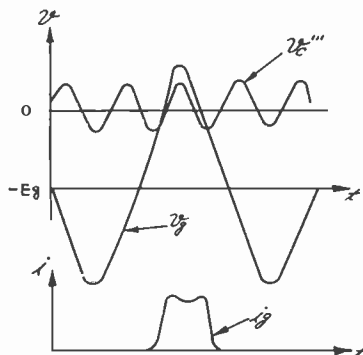

FIG. 7B. With the cathode resonator operating at the third harmonic the grid to cathode voltage modifies the cathode emission to produce a rectangular pulse of grid current. Again the higher average level of the signal has been increased, and this results in higher operating efficiency.

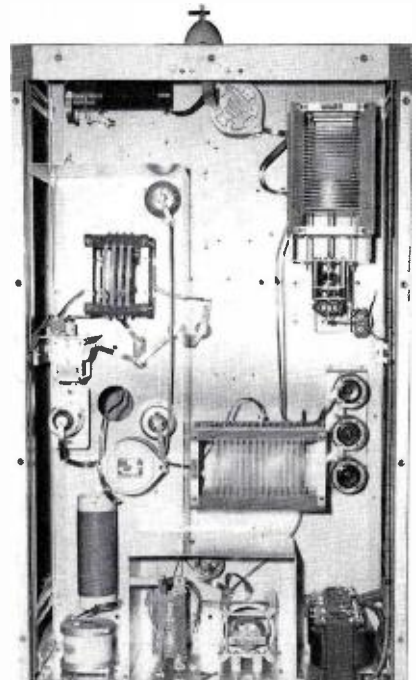

FIG. 9. This is a rear view of the new high efficiency PA and modulator stages. Removal of the rear panel provides complete access to all circuit components for ease of maintenance.

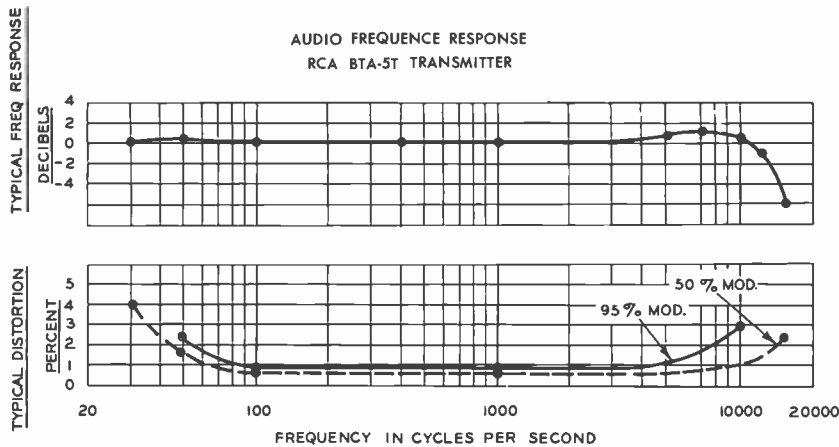

FIG. 8. Typical response and distortion curves for the BTA-5T. The high efficiency PA stage actually helps to improve the overall performance of the transmitter.

end panels to form a basic "H" cross section. The front doors give immediate access to tubes, feedback ladders and overload relays, which are mounted on the vertical chassis (see Fig. 2). Remaining components are mounted on the rear of these chassis, behind removable rear panels, while the large power components are mounted on the base of the cabinet. This type of construction offers excellent accessibility, while retaining the compactness of the transmitter (see Fig. 9).

Proved Design

A simplified schematic of the BTA-5T transmitter is shown in Fig. 6. The exciter unit, the PA modulator driver stages and the high-level linear modulator remain essentially the same as in BTA-5R/5R1 transmitter. The power supplies are silicon rectifier type. New instantaneous circuit breakers are employed in the control circuits. The plate-modulated power amplifier is of course improved by virtue of the new high-efficiency technique and the resultant power and tube savings.

Only Two Tuning Controls

The BTA-5T transmitter has only two front panel tuning controls with one local-remote power control. The driver stage is tuned by means of a slug-tuned coil, and the PA by means of a variable vacuum capacitor. Remaining circuit adjustments, necessary only at installation, consist of tap changing in accordance with the calibration chart. The PA plate resonator is adjusted by means of a front panel screw-driver slot actuating a variable vacuum capacitor. Capacitor of the cathode resonator is adjusted in similar manner. Both capacitors are adjusted for peak of the line ammeter. The variable vacuum PA neutralizing capacitor, employed in conjunction with a broadband neutralizing transformer is also preset at the initial installation.

Semiconductor Power Supply

The BTA-5T uses silicon-type rectifiers throughout. This type of rectifier offers excellent reliability in normal operation and even more so in a remote-control applica-

tion. The transmitter will operate within ambient temperatures from -20 to $+45$ degrees and up to 7500 feet above sea level.

The proven reliability high-voltage rectifier (see Fig. 10) is arc-back protected for trouble free operation, requiring neither warm-up time nor thermostatic cooling control. It carries an over-current safety factor of 200 percent, or in other words, it is capable of continuous short circuit operation. The peak inverse voltage rating is 180 percent, allowing 30 percent above the starting transient and the silicon peak inverse voltage safety factor.

The bias and low-voltage rectifiers are sealed silicon units permitting a more reliable operation.

Complete Overload Protection

To increase reliability, improvements were made in the control and protective circuitry of the BTA-5T transmitter. Primary lines are protected by circuit breakers with instantaneous and thermal overload trip protection. The 3-phase blower motor

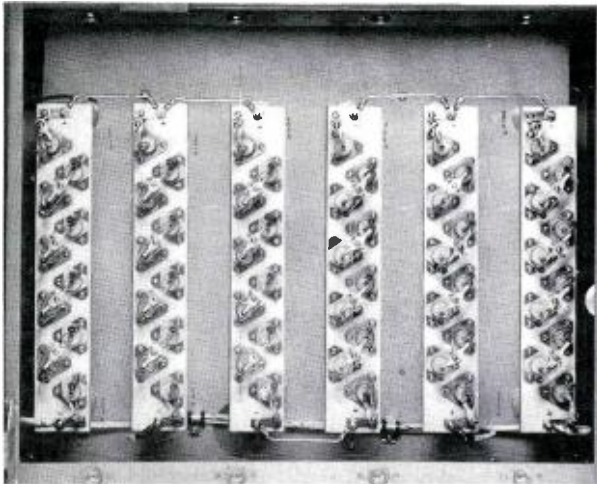

FIG. 10. The silicon high voltage rectifiers, shown here, consist of two legs each containing 30 diode units. This rectifier unit was designed with a 200 percent safety factor for increased reliability.

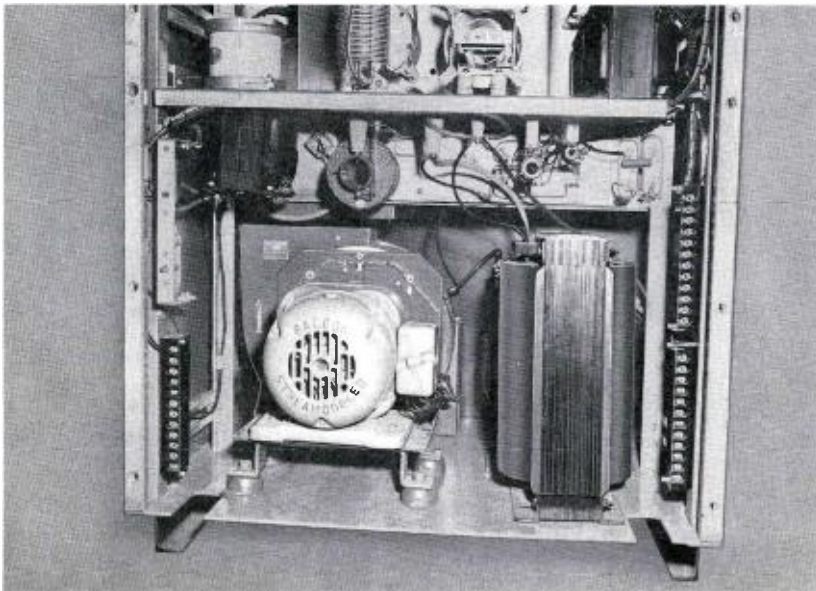

FIG. 11. The new high efficiency PA permits the use of a slow speed blower. This unit is mounted on rubber shock mounts in the base of the PA cubicle.

is protected by a contactor with the thermal cutoff in each phase; the relay switching is sequential so that the filament will not come on unless the blower is operating. Starting surges in the plate transformer, high-voltage reactor, and the filter capacitor are eliminated by the use of step-start and damping circuit.

Protected Cooling System

In keeping with modern trends, the transmitter is air cooled. Added refinements such as a delay relay have been built-in, to keep the blower system in operation for one minute after the transmitter has been shut down. This continues the supply of air to extend tube life. As the result of the high efficiency, the air pressure has been

reduced, permitting use of a slow-speed blower unit, resulting in quiet operation (see Fig. 11).

Functional and Economical

Many years of design experience are reflected throughout. Functional styling predominates affording convenience of operation, furthermore, the user has a choice of red, or gray doors to enhance the station decor.

Emphasis, however, has been placed on the reliability and the dependable performance of the transmitter. This will result in many years of trouble-free operation. Power savings achieved by the new high-efficiency circuits provide for economical operation without sacrifice of performance.

DISTINCTIVE FEATURES OF THE BTA-5T

1. High efficiency circuits in the new transmitter offers an average power input saving of 15,000 kilowatt hours/year at a continuous program operation.
2. Very low plate dissipation in the output stages reduces the heat dissipation within the transmitter, and also permits use of a quiet slow-speed blower.
3. Expensive power amplifier tubes reduced from 2 to 1. Fewer tubes throughout—a total of twelve—which also saves on tube replacement cost.
4. All semiconductor type, hermetically sealed silicon rectifiers are of proven reliability.
5. Complete overload protection is provided for all circuits. All line breakers carry an instantaneous over-current protection, while main breakers retain the instantaneous and thermal protection combined. The remaining circuits are protected by fast acting overload relays with provision for external indicators.
6. Built-in provision for the remote control, conversion to Conelrad, power cutback and a carrier off monitor is retained with improvements.
7. Meets new FCC Spurious Emission requirements.
8. The new style cabinets offer excellent accessibility to all components and allows a great saving in the floor space.



FIG. 1. These skilled technicians are assembling headwheels for TV Tape. Individual attention is given to each assembly: one technician follows each headwheel through all stages of its assembly, alignment and test. He positions heads in the headwheel with respect to pole-tip protrusion, tracking, quadrature and balance.

A TOUR THROUGH THE TV

*Here's Why We Believe This Is
the World's Finest Facility for
the Manufacturing of Precision
Headwheels for Television Tape*

Superior performance in television tape recorders starts with the care and precision with which magnetic headwheel assemblies are manufactured.

In recently expanded manufacturing facilities, RCA has developed techniques for *ultraprecision* fabrication of magnetic heads—TV tape heads and headwheel assemblies as well as complex multichannel heads for electronic data processing equipment. Also master erase, control track, and audio heads for TV Tape.

The kind of precision and craftsmanship required in the manufacture of magnetic heads rivals that employed in the making of fine watches and chronometers. Measurements are made with extreme care, test equipment is calibrated to nearly perfect accuracy. Tolerances are held to the order of one ten-thousandths of an inch—about one-thirtieth the thickness of a human hair.

The photos shown on these pages simulate a tour of the RCA magnetic head and

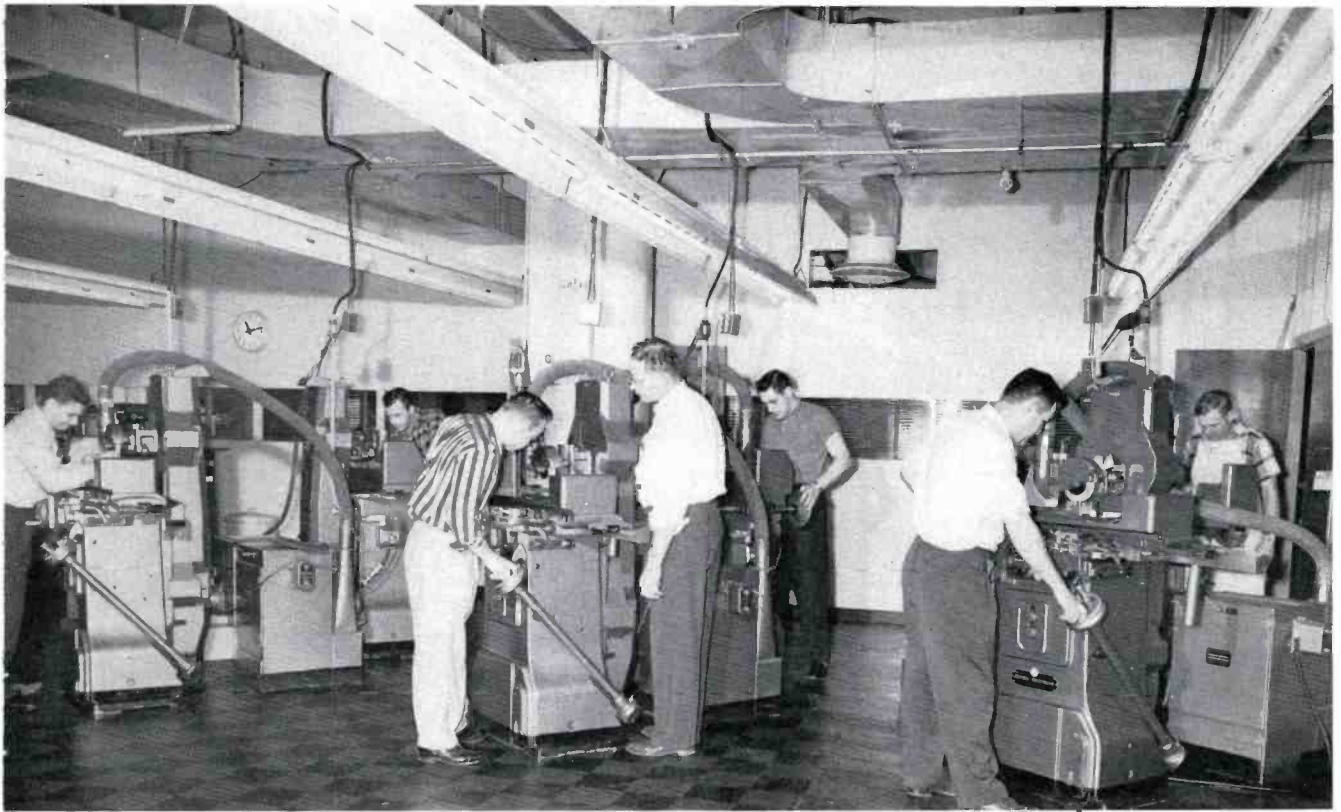

FIG. 2. The high precision surface grinders installed in this dust-free, humidity-conditioned machine shop are the best money can buy. Operated by most highly skilled machinists, they are used to shape the tiny pole tips of TV Tape heads. Grinding operations have an accuracy of about one ten-thousandths of an inch.

TAPE HEADWHEEL PLANT

FIG. 3. A group of eight magnetic heads (for two headwheels) are being machined in this special fixture. Pole tips are ground to the correct width and distance from the reference side of the head. Each pass of the grinding wheel removes less than 0.0001 inch of material — it would take 15 to 20 passes to reduce a human hair to half its thickness. Heads for two complete headwheels are machined together. They are cataloged and kept together for all future operations to assure utmost uniformity of heads in each headwheel.

headwheel manufacturing facilities. They show fabrication of the tiny magnetic heads, assembly and alignment of the headwheels, and final test of the finished headwheel panels. This group of photos illustrates why we believe this is the finest, most up-to-date facility manufacturing precision headwheels today.

Together with the latest advances in electronic circuitry, this newly acquired mechanical precision and know-how accounts for the extra measure of picture quality telecasters have come to expect from RCA.

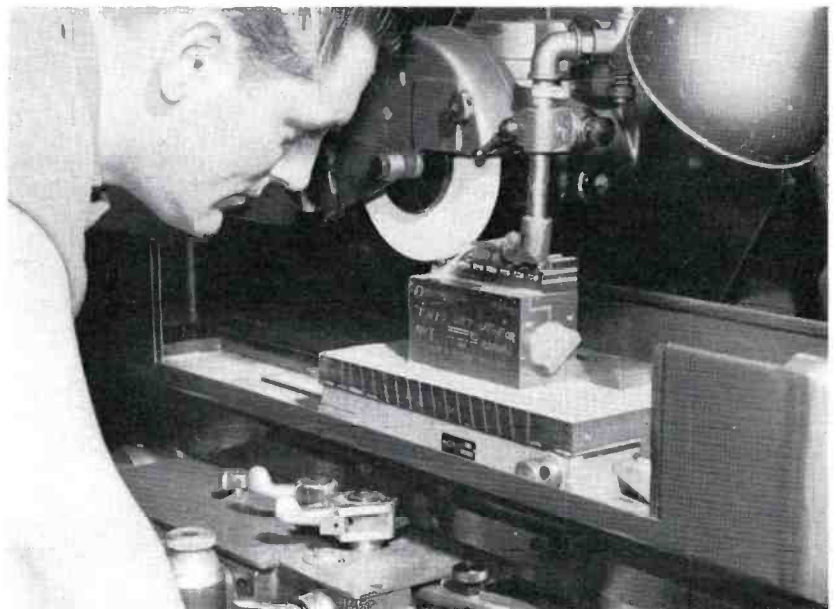

FABRICATION OF MAGNETIC HEADS



FIG. 4. The tiny components of the TV Tape magnetic head are assembled on production lines such as this. Operators work in a world of powerful magnification, inserting pole tips into head blocks, wiring tiny cores, assembling the various components which make up the completed magnetic head.



FIG. 5. Here, pole tips are being inserted and cemented into head blocks prior to machining. This is the initial stage of head fabrication. Two of these blocks are joined together in the following process to form a single video head.



FIG. 6. After machining, the two halves of the magnetic head are cemented together using a special fixture. At this point the gap spacer is inserted between pole tips. The gap spacer is hardened beryllium copper foil rolled to a thickness of less than 0.000095 inches.



HEADWHEEL ASSEMBLY AND ALIGNMENT

FIG. 7. Individual heads are placed in special alignment fixtures, and accurately set with respect to pole-tip protrusion, tracking, quadrature and balance. Once rigid specifications have been met, the heads are transferred and cemented to the headwheel assembly.

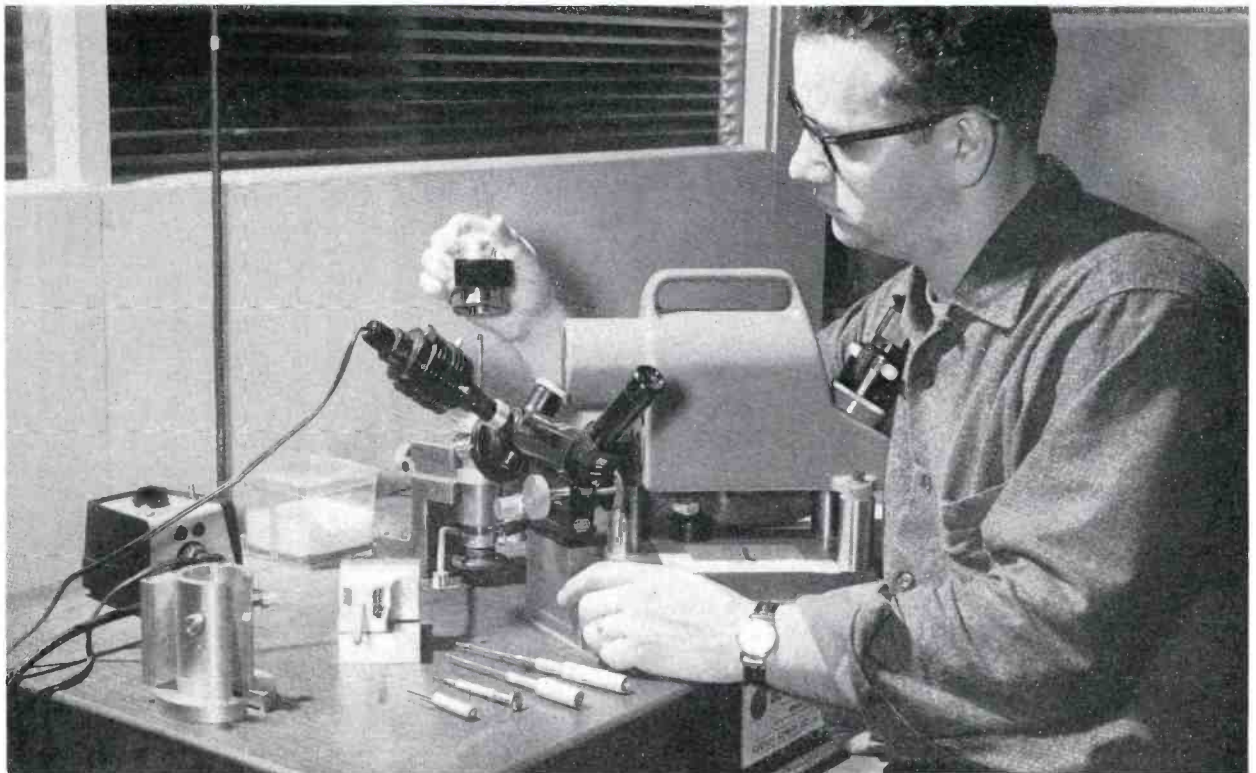

FIG. 8. Setting quadrature alignment of the four video heads gets special attention. Using collimator and an optically accurate reference square (shown in the technician's hand), the 90-degree angles between heads can be set to ± 15 seconds of arc. Two straight lines separated by this tiny angle are displaced only four inches at a distance of one mile. In tape recording and playback operation, further quadrature precision is made possible by the use of electrical delay lines.

FINAL TEST OF HEADWHEEL PANEL

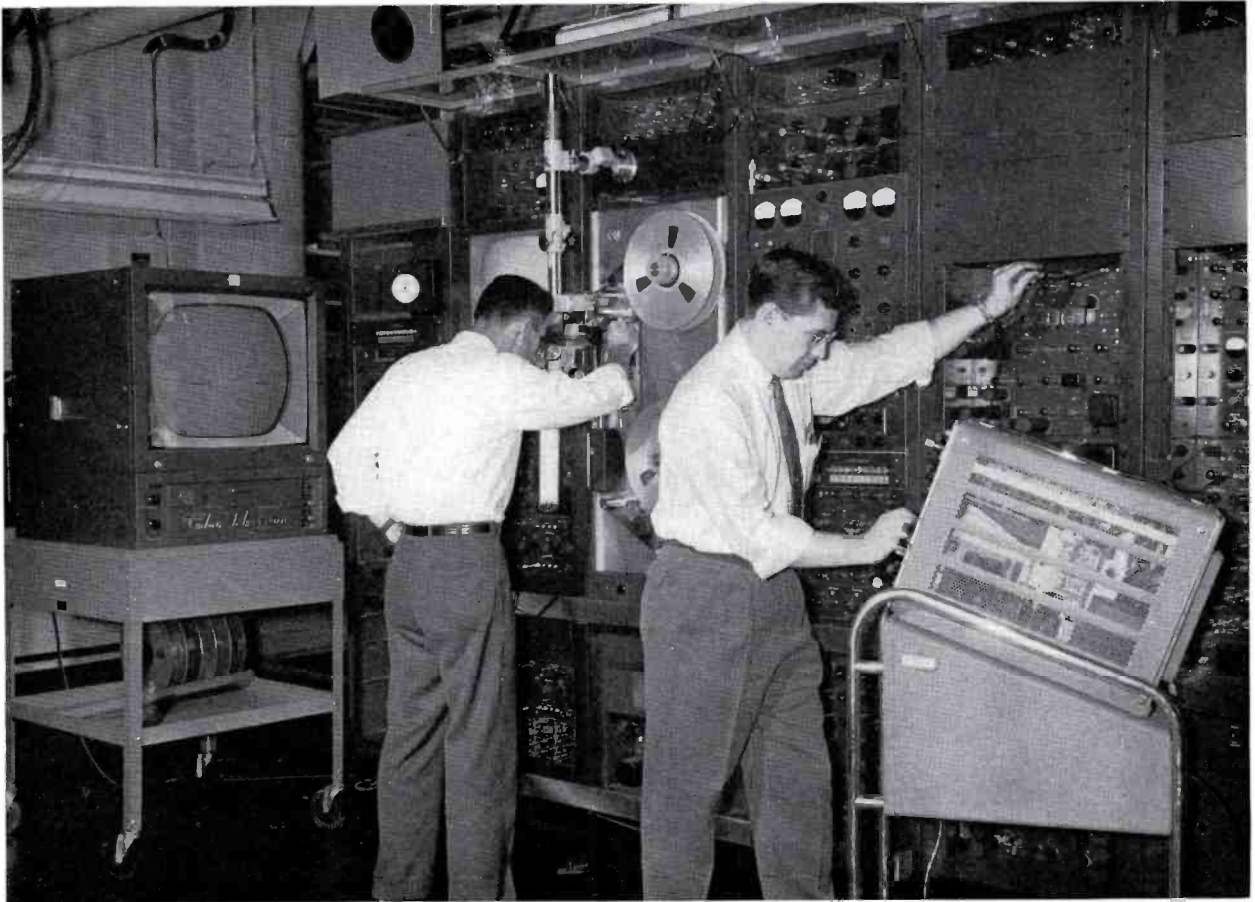

FIG. 9. The performance quality of the completed headwheel is confirmed by actual "in-operation" tests. These are conducted on TV tape recorders set up to perform as "operating standards" for test and alignment procedures. Each headwheel panel receives exhaustive operational tests. Extremely tight specifications must be met for signal-to-noise ratio, picture stability, quadrature, shoe position and operation, control track operation and other important details. In addition, each headwheel panel is fully tested for color operation which further substantiates its superior performance for black-and-white.

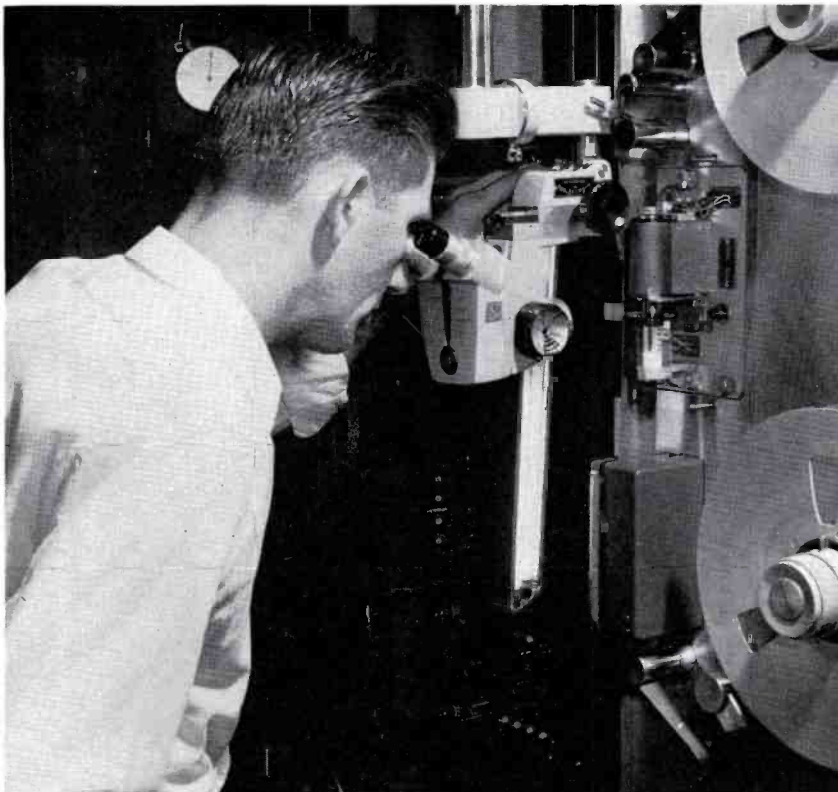

FIG. 10. Upon completion of the test run, the headwheel is microscopically re-examined for mechanical flaws. It is checked and double checked for any evidence of piling up of oxide, faulty brush or slip ring performance before it is given a final "OK-to-ship".

TV TAPE SPLICER

*Precision Splices Made Easy With New
Equipment Featuring Shear-Type Cutter,
40-Power Microscope and Slide-In
Tape Dispenser*

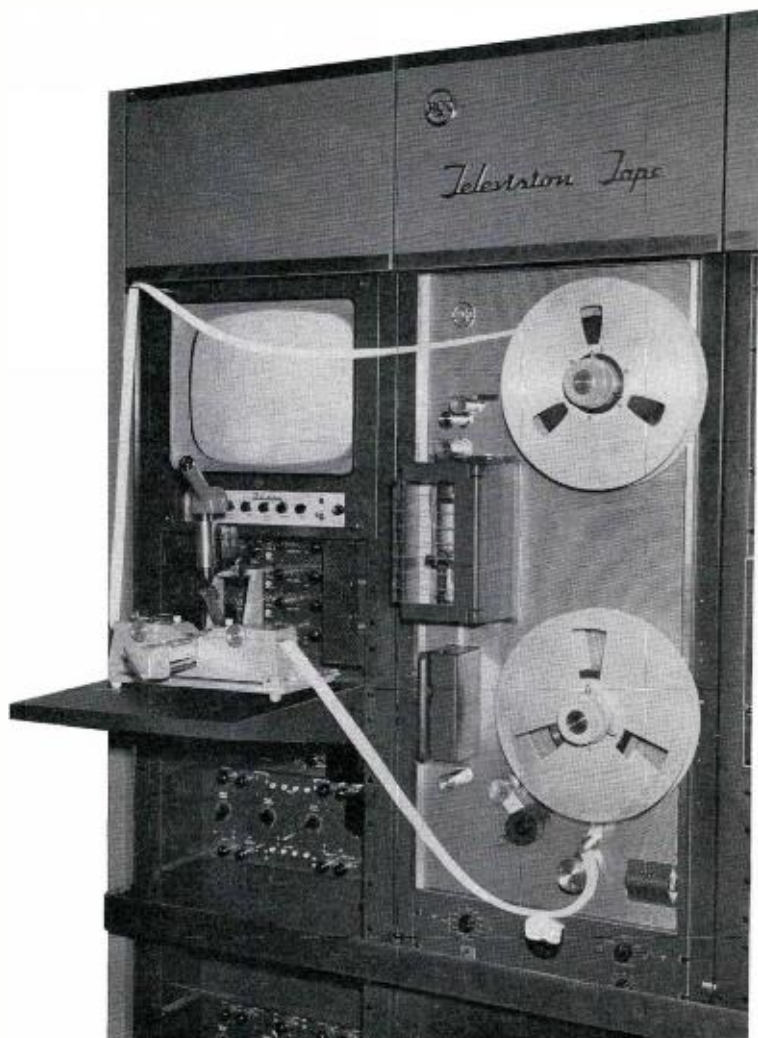

FIG. 1. The splicer is provided with a sturdy shelf which can be bolted to the TRT-1A TV Tape Recorder for conveniently making splices at the record/playback location.

Quick, accurate tape splices are now made possible with a new high-precision TV tape splicer. A forty power microscope with graduated mil scale combined with a precisely machined shear-type cutter, accurate to .0005 of an inch, give you the kind of control you need for practical, efficient tv tape splicing. Other features include a slide-in splicing tape dispenser, vernier tape adjustments, neoprene cushioned tape locking devices, and a fold-a-way edge light.

The tape splicer has a number of lock-in adjustments which afford all the means for forming clean, solid, square butt-splices. With a minimum of time and effort operators can make perfect splices thus eliminating roll-over and other "splice-faults" of television tape programming.

The splicer consists of a sturdy base plate upon which an optical system and splicing components are mounted. The splicer body has a precision tape guide, measuring two inches wide by $\frac{1}{8}$ -inch deep, in which the tape is placed during the splicing operations. Two hinged hold-down doors secure the tape in the tape guide and two vernier tape advance knobs control tape movement in the guides, allowing the operator to align the tape under the cutting shear. When properly positioned for the cut, the tape is secured by means of tape locks.

A light assembly containing a 6.3 volt screw-base lamp is hinged to the top of the left hand tape hold-down door. It is swung into position to light the splicing area while

the optical alignment is being made and swung back to the "rest" position while the splice is being made.

Another feature of the splicer is the saddlebar which slides through the ways in the splicer body at right angles to the tape guide. It carries the shear into position for cutting and the splicing tape into position for the splicing operations. The tape shear is mounted on the back end of the saddlebar assembly, and is made of a special alloy, hardened and precision ground. The splicing tape magazine is located on the front end of the saddlebar and contains a spring-loaded spool which holds the reel of splicing tape. The saddlebar can be locked into position to prevent the bar being moved during cutting or splicing operations.



**EASY STEPS IN SPLICING
MAGNETIC TAPE . . .
USING THE NEW RCA TV
TAPE SPLICER**

The photos shown on these pages illustrate the easy steps in making tape splices with the new tv tape splicer. By these means guesswork is eliminated and operators can be quickly trained to make perfect splices every time.

Briefly, splicing is facilitated by a forty power microscope which makes it easy to locate and align editing pulses precisely. Each splice is properly oriented eliminating time and money consuming trial and error methods. The machined cutting surfaces of the shear type cutter are accurate to .0005 of an inch to provide high precise cuts each and every time. Also a splicing tape dispenser facilitates measuring out splicing tape. It holds it fast and slides into the proper position for perfect splices. The result is neat, secure splices free of creases and bulges.

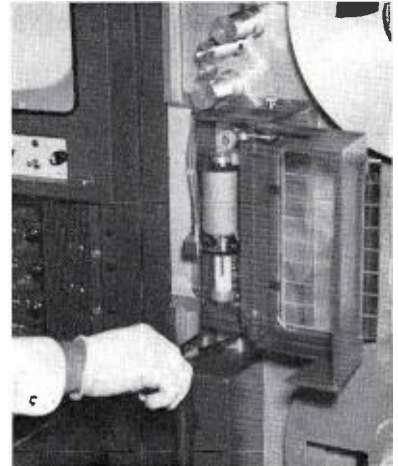

FIG. 2. First step in splicing is to stop the recorder at the desired location and cut the magnetic tape. One end of the tape is placed on the splicing shelf.

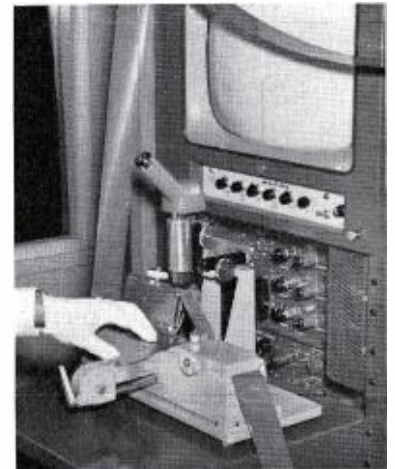

FIG. 6. Tape from the top supply reel is draped over the tape support post and placed in position under the left holddown door of the splicer.

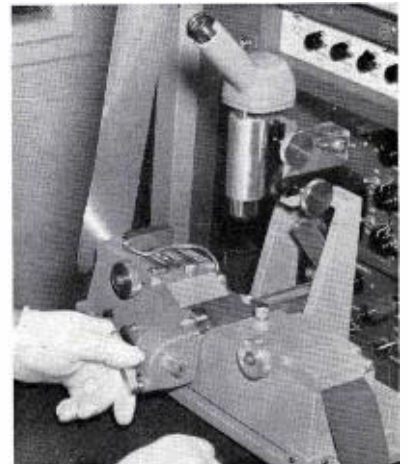

FIG. 10. The splicing tape is inserted beneath the lifted ends of the two tapes which are to be joined.



FIG. 3. The nearest "edit" or "frame" pulse is located by dispensing a liquid solution of iron oxide particles on the tape. This develops the magnetic pattern.



FIG. 4. The edge of the video track is lined up on the reticle built into the microscope. When properly aligned, the shear type cutter will cut the tape half-way between adjacent video track.

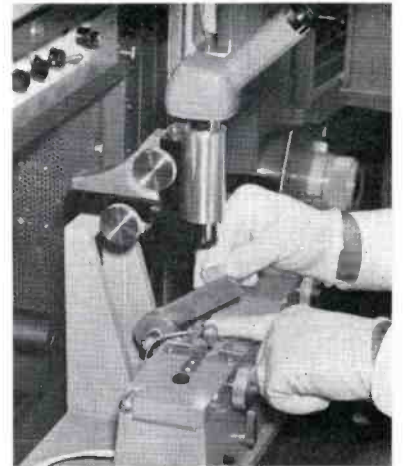

FIG. 5. Next the shear type cutter is brought in position and a cut is made.



FIG. 7. The tape track is again aligned prior to making the precision cut necessary to match the two ends of the tape.



FIG. 8. Again the shear type cutter is brought in position and another cut is made.

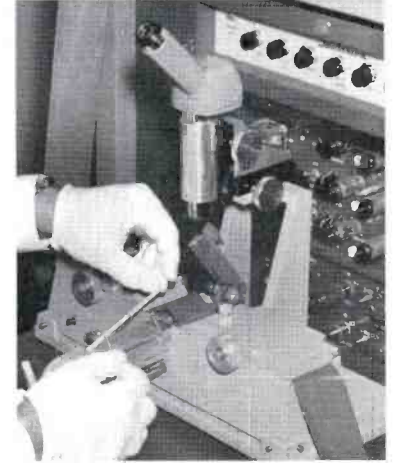

FIG. 9. The splicing tape is pulled out of the dispenser and placed under the guides which hold it secure.



FIG. 11. Using roller tool supplied with splicer, both ends of tape are pressed firmly against splicing tape to provide a perfect butt joint.

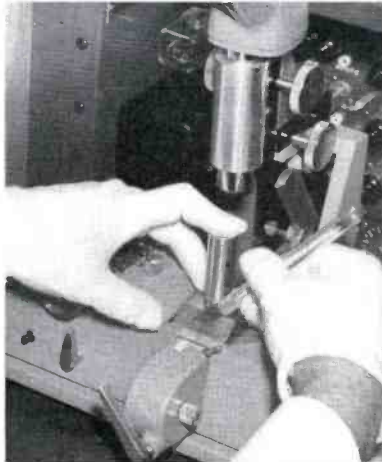

FIG. 12. The excess splicing tape is trimmed by means of the special trimming tools provided with the splicer.



FIG. 13. A clean, solid, square butt splice results. This will be free of roll-over and other splice faults of TV tape programming.

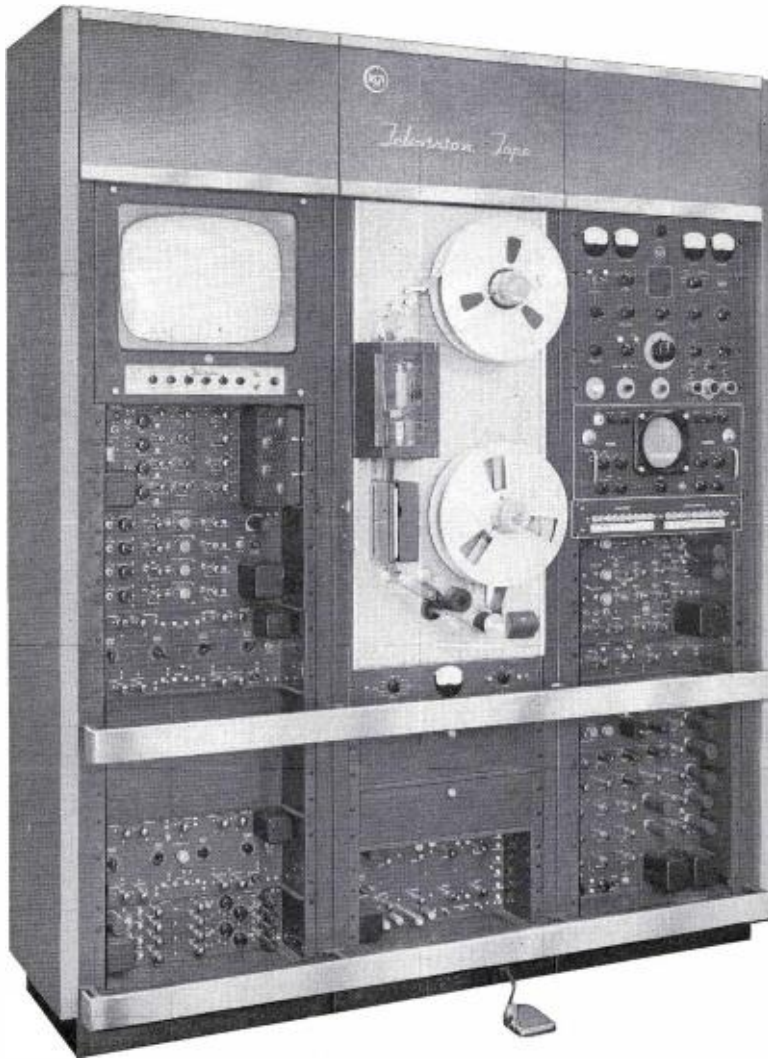

FIG. 1. The tape transport mechanism is located at the center panel of the three-rack Operations Center. The control panel, waveform and picture monitors, are located at adjacent racks for convenience of operation.

HOW DESIGN OF TAPE TRANSPORT MECHANISM IMPROVES PERFORMANCE OF TV TAPE RECORDER

by JOSEPH G. LEE,
Radio Corporation of America,
Camden, New Jersey

The potential of the Television Tape Recorder in the realm of the television industry is almost unlimited. However the application of the recorder to TV programming is still in its infancy. Hence any useful information about the operation and maintenance of the machine is particularly appropriate at this time.

Although the equipment is largely electronic, the very heart of the machine, the

tape transport panel, which handles the tape from supply reel to the take-up reel, is mechanical in nature. This unit consists of a transport assembly to move the 2-inch tape over the various recording and pickup heads, while maintaining correct speed and tension to give the required performance. At the same time the equipment must record the audio, video, and control signals on the tape in accordance with SMPTE standards.

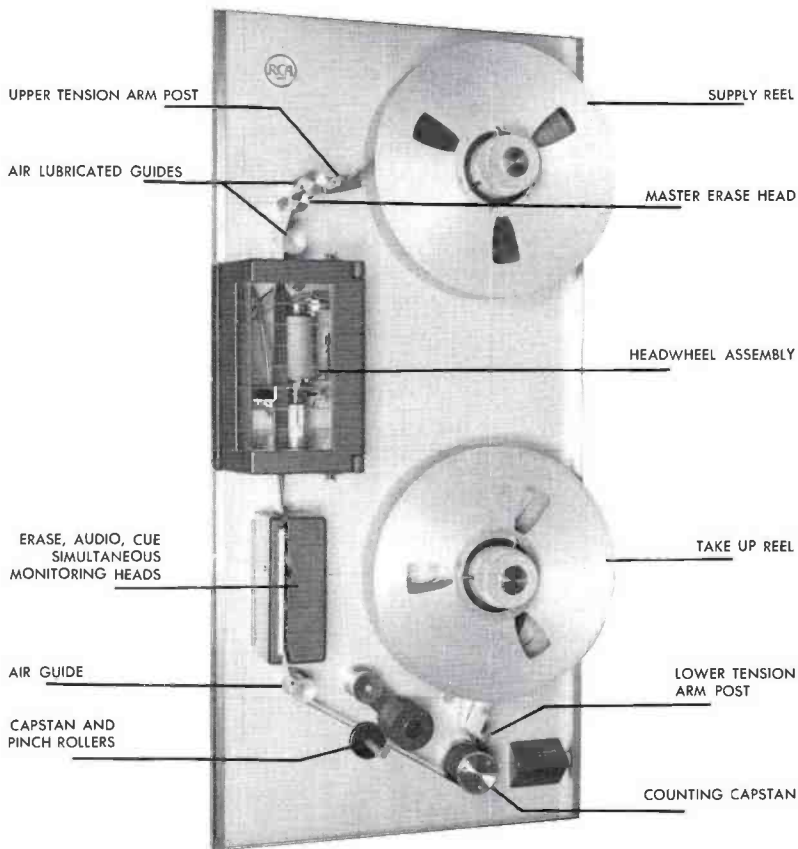

FIG. 2. View of the tape transport panel showing location of key components.

Transport Mechanism is Key to Operational Simplicity

The transport mechanism for the TRT-1A Television Tape Recorder fulfills the foregoing basic requirements. As shown in Fig. 1, the tape transport is the center panel of the three-rack Operations Center. The control panel is on the right; the picture monitor is on the left. This arrangement provides convenience in operation plus the benefits of rack-mounted accessibility. Following the tape from the supply reel (see Fig. 2), it passes under the upper tension arm post, the purpose of which is to take up excess tape. Next, there are two air-lubricated guides, preceding and following the master erase head (see Fig. 3). These guides position the tape for approach to the head wheel. Air lubrication of these and other guides on the panel results in minimum wear on the tape as well as very accurate tape positioning. Next the master erase head automatically erases any previous recorded signals before recording. Then video and control signals are either recorded on or read from the tape by the headwheel assembly. Now the tape passes over the erase, audio and cue, and simultaneous monitoring heads. Another air guide (the third) changes tape direction for approach to the capstan and pinch rollers. These rollers clamp the tape against the capstan, which controls the tape speed (see Fig. 4).

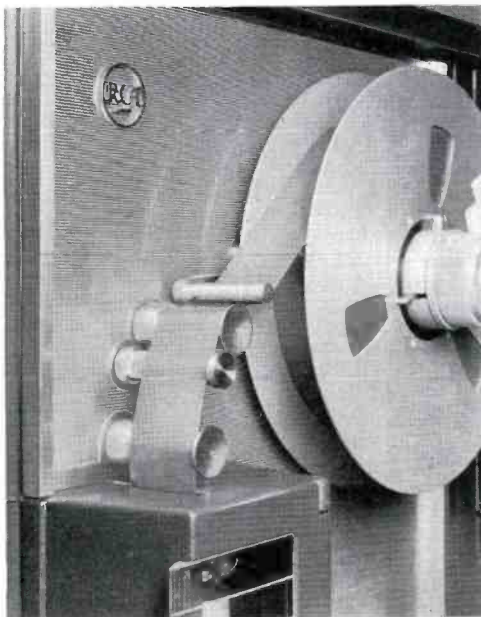

FIG. 3. The master erase head which provides automatic erasure of the tape prior to recording is located between the two cylindrical air-lubricated guides.

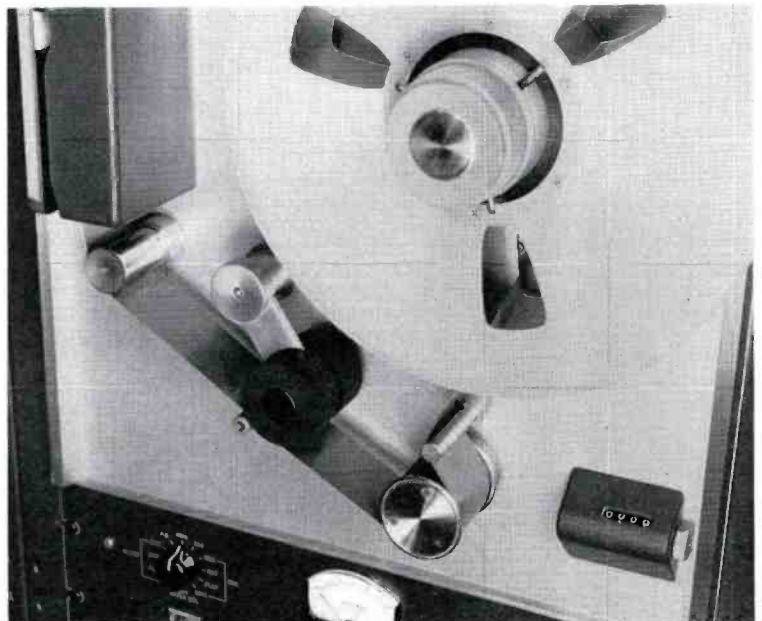

FIG. 4. Close up of the take-up reel showing air guide, capstan and pinch rollers, and counting capstan. Tape footage is clocked off on the indicator shown at the right. The indicator may be reset to zero prior to each recording if desired.

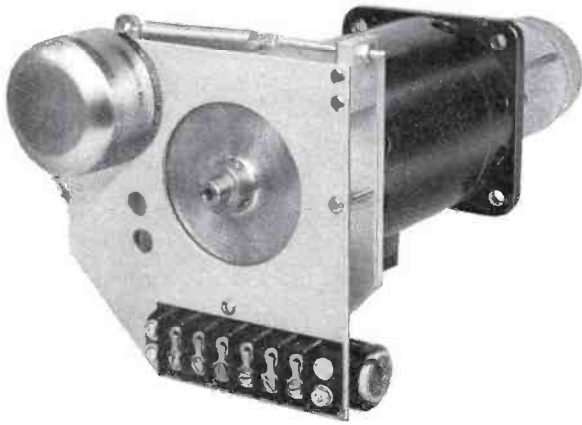

FIG. 5. Reel motor, hub and brake assembly. Precision design of these components assures gentle tape handling and extremely accurate control of record and playback functions.

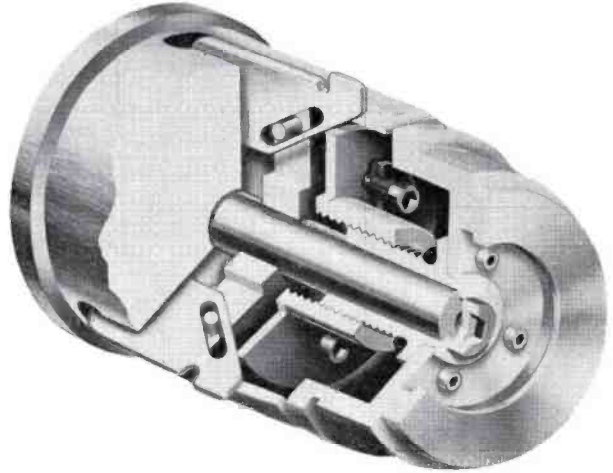

FIG. 6. Cut-away view of the reel hub assembly. Unique design of this assembly assures that reels are held very securely to the motor shafts, yet allows easy removal and replacement of tape reels.

Finally the tape passes over a counting capstan and lower tension arm post before going to the take-up reel. Tape footage is clocked off as the tape rotates this counting capstan.

Structural support for the transport consists of a cast aluminum plate, precision ground on both sides to a thickness of one-half inch. It is fastened to two-by-three-inch extruded aluminum angles attached to the rack frame along each edge. All assemblies and components, except the air guides and master erase head, are fastened to the cast aluminum plate using tapped holes.

Precision Reel Motor and Brake Assembly Assure Gentle Tape Handling

The reel motor, hub, and brake assemblies, Fig. 5, are key units in tape handling. Attention to precision design of these components in the TV Tape Recorder assures gentle tape handling and extremely accurate control of record and playback functions. This contributes in part to the superior performance characteristics of the machine.

Reel motors are of induction torque design, with a rating of 65-inch ounces at 75 volts. During rewind the upper motor is fully energized and starts at a maximum speed of 875 rpm, decreasing as the reel fills. When rewinding at maximum speed, the lower motor is energized to rotate counter-clockwise with approximately 50 volts. However, its direction of rotation is clockwise, and its speed is determined by the

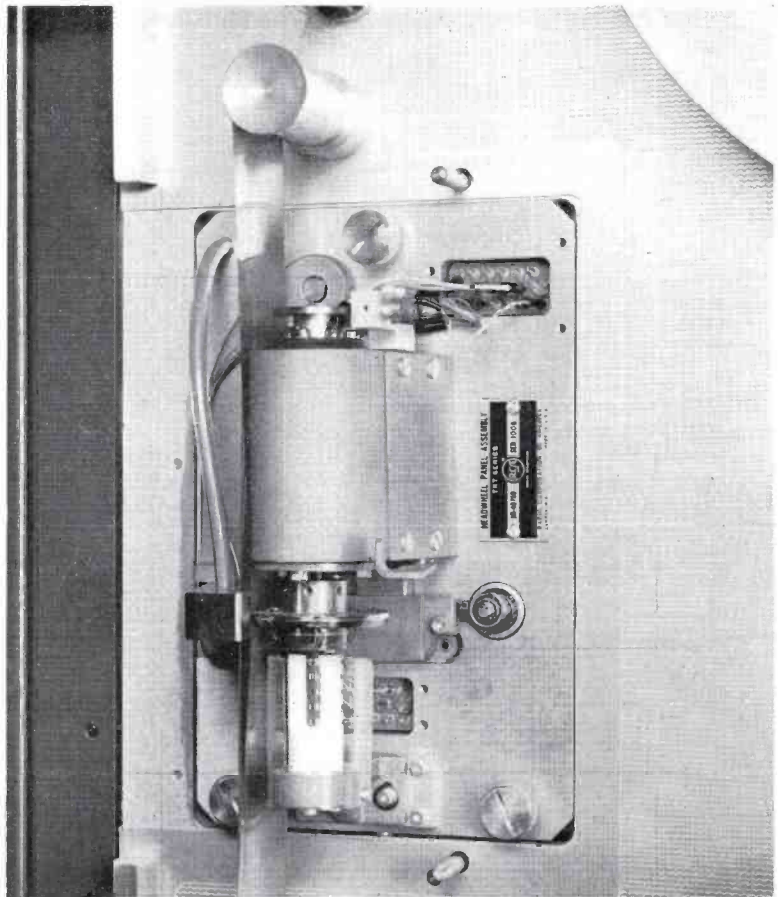

FIG. 7. Headwheel panel assembly. Principal parts of this assembly are the motor, headwheel, slip rings and brushes, tone wheel and shoe.

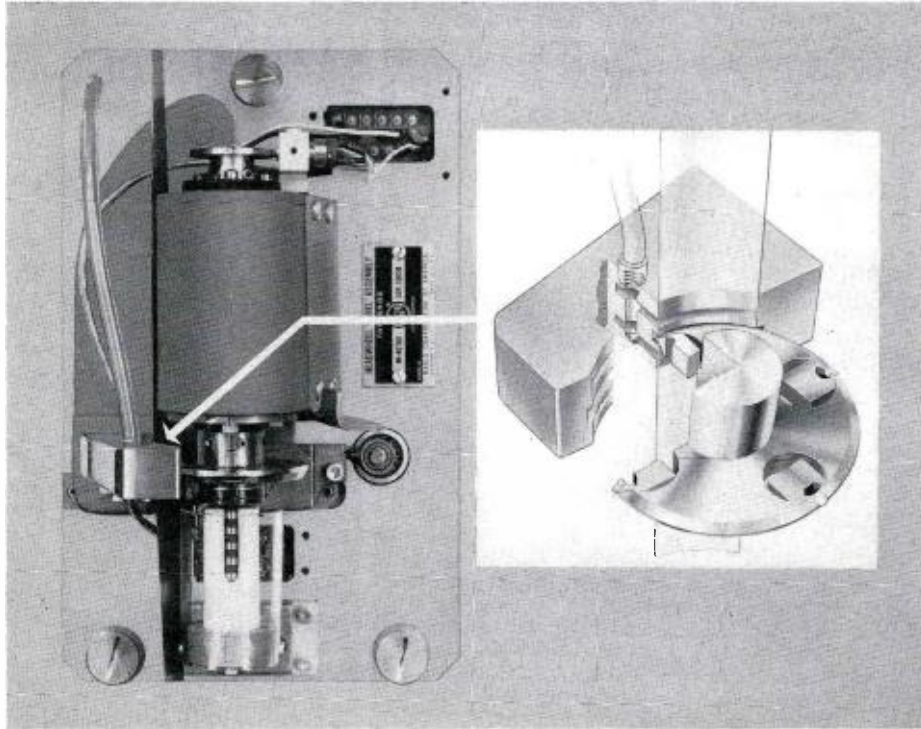

FIG. 8. Cut-away view of the tape shoe showing slot construction and relationship of shoe to headwheel.

tape speed, which increases with the radius of the upper reel. In the play condition, both motors operate at constant torque; the supply motor operates at slightly below 5 inch ounces, the take-up motor at 10 inch ounces.

Reel hub assemblies, which hold the reels very securely to the motor shafts, are uniquely designed. There are three pawls (see Fig. 6) that clamp the reel against the hub flange. The pawls ride in three equally spaced slots in the hub. When the knob on the reel hub assembly is turned counter-clockwise, the pawls are disengaged and the reel can be removed. A clockwise turn reengages the pawls and the reel is clamped fast.

Braking is fail safe since the brakes are comprised of asbestos-lined bands on brass drums and are spring actuated and solenoid released. The linkage is arranged to give differential braking on approximately 240 degrees of the drum. This is advantageous in keeping the tape tight during stops from high speed wind and rewind.

Headwheel Precision

The transverse recording of the video signals is performed by the headwheel panel assembly (see Fig. 7). The principal parts

of this assembly are motor, headwheel, slip rings and brushes, tone wheel and shoe. The motor is a 3-phase, hysteresis-synchronous type, running at a nominal speed of 14,400 rpm. It is surrounded by a shroud which serves as a magnetic shield and air duct for cooling. Air is drawn in at the headwheel and exhausted through the mounting plate to the low pressure vacuum pump. The headwheel is a 2.0642 inch diameter non-magnetic wheel with four equally spaced magnetic pick-up heads mounted in it. The poles of these heads protrude approximately 0.004 of an inch.

The headwheel and motor assemblies are the most precise parts of the equipment. To insure complete interchangeability, that is, the ability to play any tape recorded on other machines, quadrature of the heads in the wheel is set at the factory to within plus or minus 15 seconds of 90 degrees. This is equivalent to plus or minus 0.05 micro-seconds of time with the wheel rotating at 240 rps.

Electronic Quadrature Control

Electrical delay line adjustments are provided so that final headwheel quadrature accuracy within plus or minus 0.01 micro-seconds can be obtained by a simple quad-

rate control built into the equipment. This electronic adjustment of quadrature can be made while the recorder is in operation, thereby allowing the operator to optimize his adjustments while viewing the picture, i.e. test pattern or bar signal.

Jitter Protection

Any speed change around the periphery of the headwheel will cause a lateral shift of an element of the video picture. The effect of this change is referred to as "jitter". Maximum permissible jitter in the RCA TV Tape Recorder is plus or minus two micro-seconds. The stability required to meet this specifications is better appreciated by considering that one revolution of the headwheel is 4167 micro-seconds.

Since mechanical components contributing to jitter are bearings and balance, selection of these are extremely important. Ball bearings used in the motor are ABEC Class 7, selected for less than 50 micro-inches eccentricity and for low noise. The latter requirement necessitates a very fine finish on balls and races.

Precautions Against Skewing

The shoe (see Fig. 8) is a solid block of non-magnetic material with an inner radius of 1.0329 inches, containing three machined

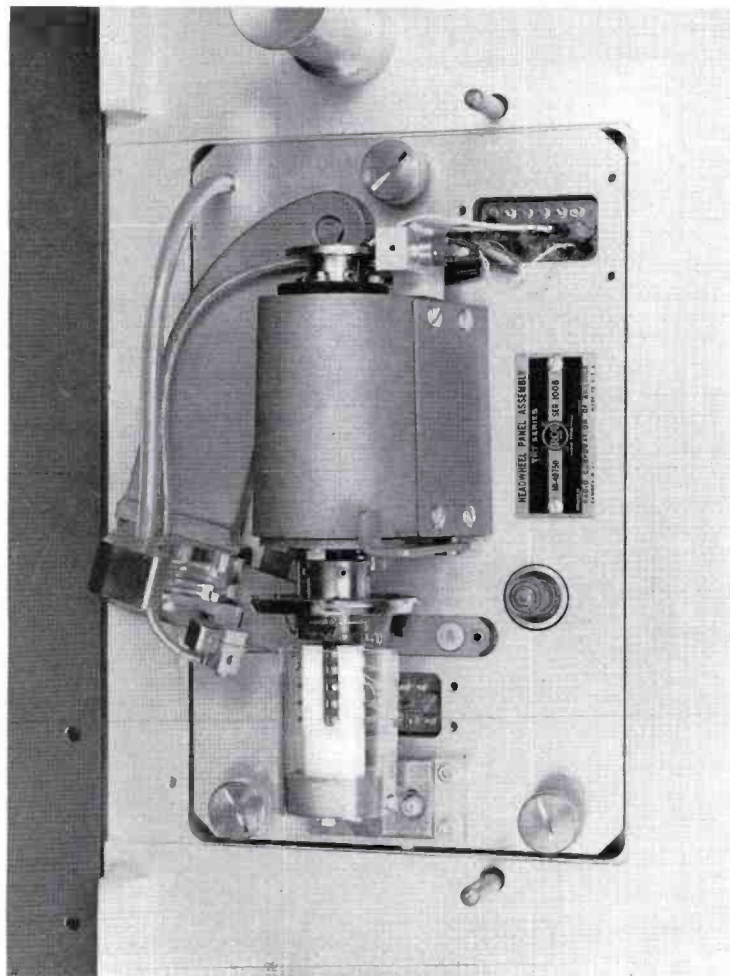

FIG. 9. Headwheel panel assembly with the shoe swung away. The small block shown at the base of the shoe is the magnetic head which records the servo-control track.

slots. The center slot is for the pole piece protrusion. The two outside slots have a vacuum of five inches of mercury applied to them in order to stabilize the tape against the shoe.

The shoe and its position are common sources of imperfections perceivable by home viewers. These imperfections appear as offsets every sixteen or seventeen TV lines. The effect is called skewing. This is caused by improper stretching of the tape as the protruding pole tips pass across it.

Protrusion beyond the radius of the shoe is necessary to assure good contact with the tape. The amount of protrusion is commonly referred to as shoe pressure. Too little pressure will cause offsets sloping to the right until loss of signal occurs. Too much pressure will produce offsets sloping to the left. The movement of 0.001 inch will produce an offset of one-quarter inch on a 17-inch monitor.

In the TRT-1A recorder a servo unit (that is fed an offset error signal) automatically corrects shoe pressure errors to prevent skewing effects on playback. In the record mode, operation of this control is electrically switched to manual so optimum head-to-tape pressure can be adjusted using a calibrated dial.

Magnetic Tone Wheel for Positive Control Of Headwheel Speed

At the top end of the headwheel motor is the magnetic tone wheel and pickup head. The tone wheel is mounted on the motor shaft, and consists of a soft iron disk with

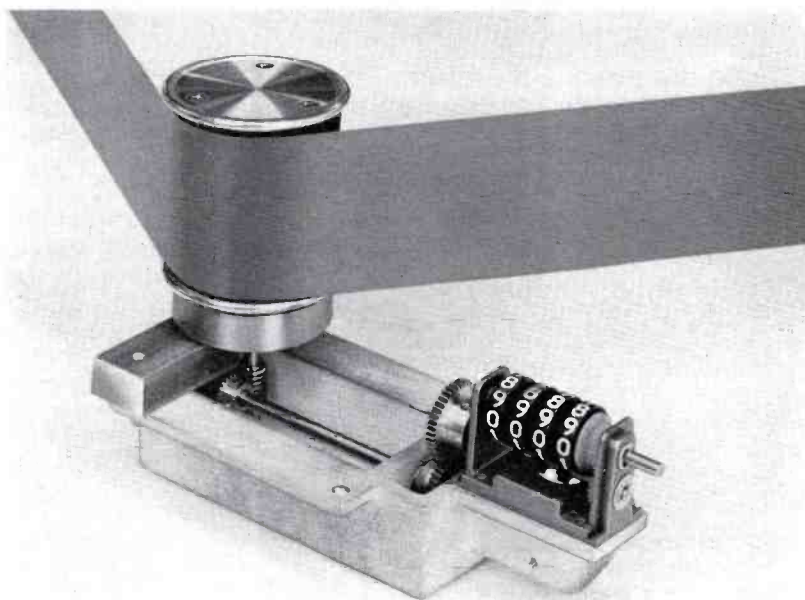

FIG. 10. Close-up of counting capstan and counter. This assembly provides direct reading of footage in order to numerically identify any point on the tape.

a notch in its periphery. The notch in the tone wheel interrupts the flux path of the pick-up head on each revolution. This interruption induces a 240 cps pulse, which is compared against a reference frequency. Thus an error signal is obtained to control the headwheel motor speed.

Servo Control Track for Positive Playback Tracking

After the tape leaves the headwheel and shoe, the inside edge passes over the servo control track magnetic head, located immediately below the headwheel (see Fig. 9). In the record mode, this head records the 240 cycle servo control track signals. During playback it supplies a signal to control the capstan servo. In this way the capstan motor keeps the tape positioned so the headwheel is always aligned with a single video track.

Holding Tape Speed Accurate

The capstan motor, running at 600 rpm, fixes tape speed at 15 inches per second. This is a hysteresis synchronous 2-phase motor with a rated running torque of 11 inch ounces. A flywheel is mounted on the capstan motor shaft to smooth out speed fluctuations.

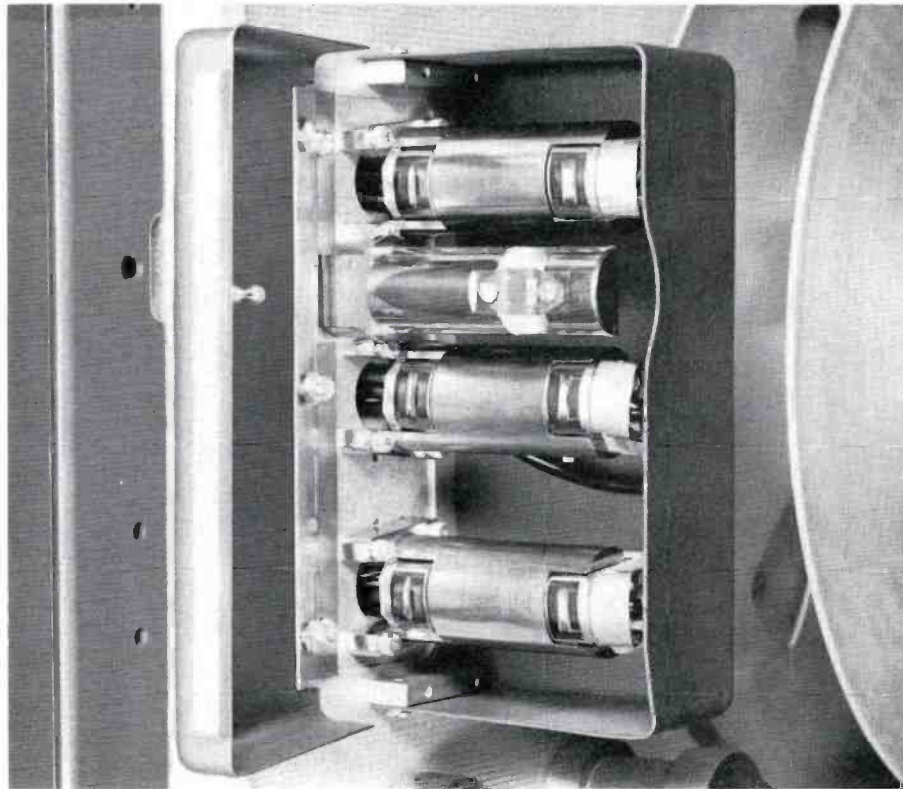

FIG. 11. Erase, recording and simultaneous playback heads are located in this assembly. The first support contains cue and program audio heads. Next is a back post, which assures proper wrap for each support. The second support holds cue and program audio heads; and last, the two heads in the third support provide simultaneous playback of program audio and control track signals.

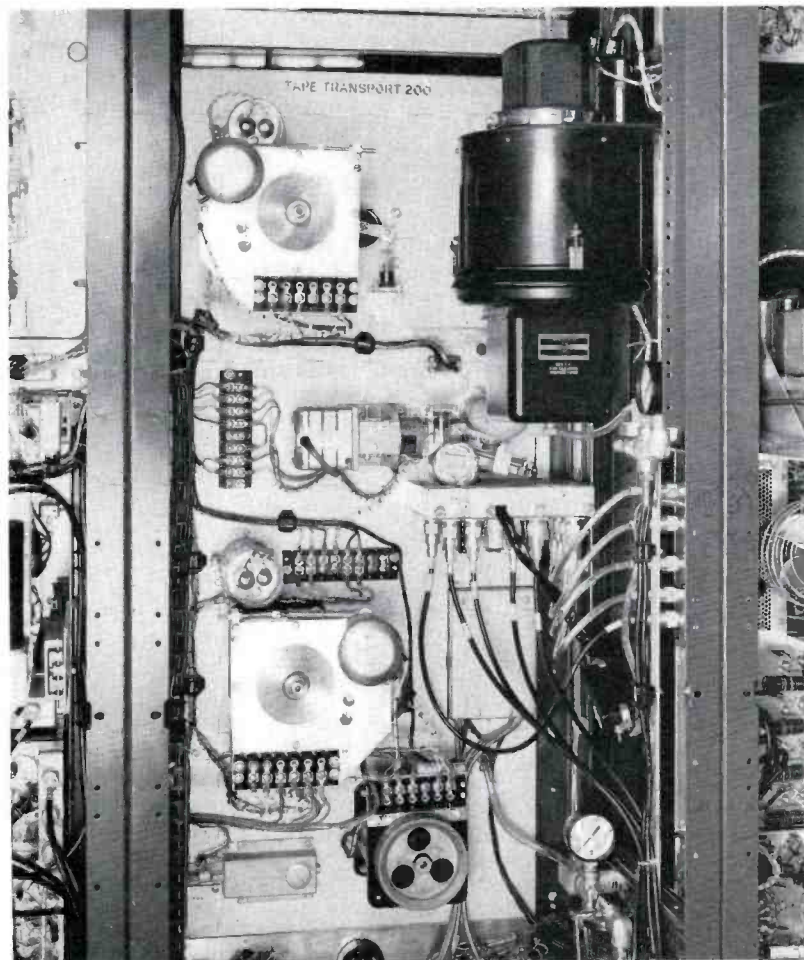

FIG. 12. Rear view of the tape transport mechanism. All connections and assemblies of the tape transport are readily accessible from the rear for extra convenience, ease of maintenance and servicing.

The pinch roller assembly is a self-aligning split roller design utilizing the controlled looseness of ball bearings (see Fig. 4). There is sufficient freedom of the shaft in the arm and of each roller on the shaft to allow the rollers to align with the capstan shaft. The pinch rollers are actuated by a rotary solenoid through a spring loaded link.

Tape Footage Indicator

To indicate tape footage, a counting capstan (see Fig. 10) is geared to a counter on the transport panel. This is a conventional four-digit counter, which adds, subtracts and records ten digits for each revolution, thus providing direct reading of footage to numerically identify any point on tape. Equipped with zero reset, the counter provides an aid to rapid cuing and quick splicing.

Audio Recording and Monitoring

After video and control track signals are recorded, excess video signal is erased so that high quality audio and cue signals can be recorded. This is accomplished by two erase heads mounted on the first support

(see Fig. 11). The second support holds the cue and program audio heads. Between the first and second support is located a back post which makes it possible to obtain the proper wrap on each support. The two heads in the third support provide simultaneous playback of program audio and control track signals. All six heads are adjustable for track location; the program audio and simultaneous program audio are also adjustable for azimuth.

Tape Tension Control

In record and playback modes, the reel motors are energized to give a fixed torque, regardless of the amount of tape on either reel. Tape tension changes because the radius of the reel changes from a minimum of 2.25 to a maximum of 6.75 inches (for a 14-inch diameter reel). This 3-to-1 change in tension causes the load on the capstan to change from holding back at the start of a reel to pulling at the end of a reel. In terms of load on the capstan, a representative change would be from -3 to $+2$ inch ounces from the start to the end of a 7200-foot reel.

Tension arms on the TRT-1A serve their normal function of taking up or paying out

tape at a faster rate than can be provided by the reel. Unilateral viscous damping has been provided to operate when paying out tape on both upper and lower tension arms. This is accomplished with unidirectional air dampers, mounted on the rear of the support panel. Damping in this manner stabilizes the tape speed more quickly in starting.

Functional Styling

The use of rack mounted equipment is traditional in the broadcast industry and lends itself to many advantages. In the TRT-1A, three racks have been brought together by decorative trim and utilitarian purpose. Two horizontal guard rails across the lower front protect the transport assembly. The transport area has a clean uncluttered appearance and is conveniently located between the control panel (right) and picture monitor (left).

In addition to giving the ultimate in performance, this tape transport was designed for ease of operation as well as maintenance (see Fig. 13). To that end every major unit can be serviced without disturbing or removing any other unit.

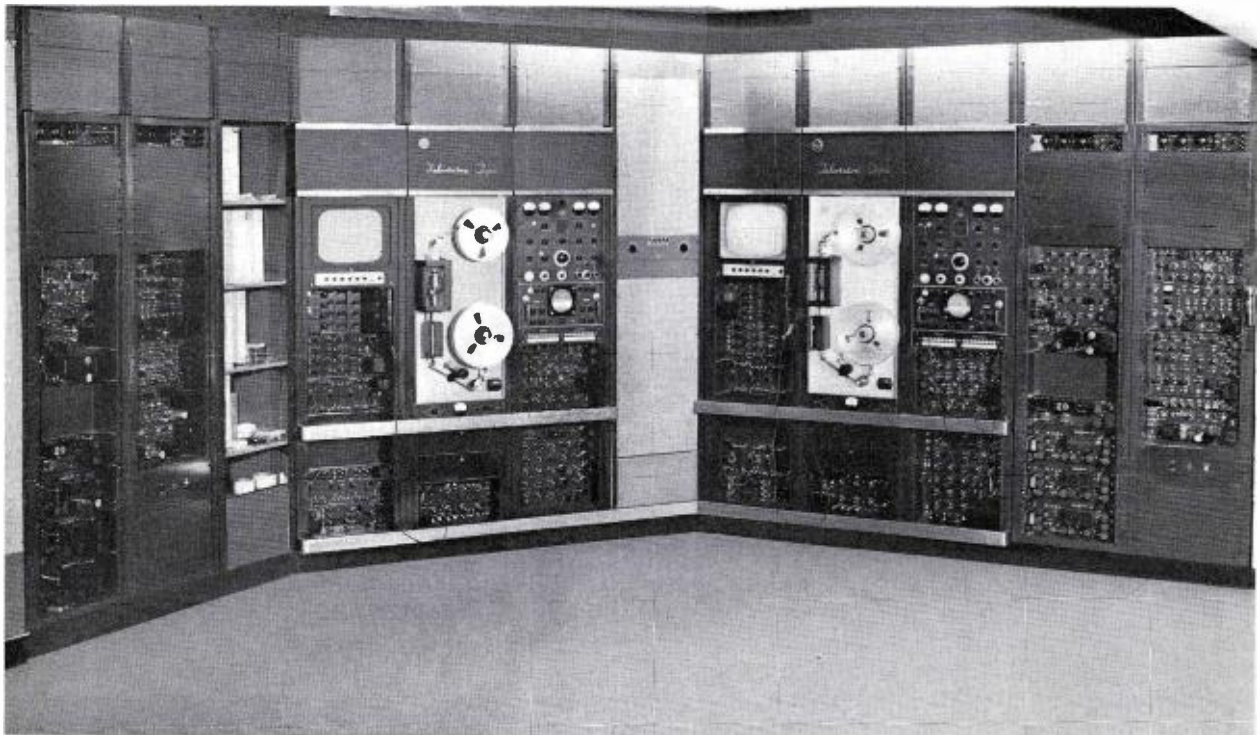

FIG. 13. Convenient rack mounted design permits installation of two complete TV Tape recorders with minimum floor space and maximum accessibility.

TAFT BROADCASTING COMPANY



TV automation at WKRC





automation at WKRC-TV opens new for the entire television industry

**full-time RCA system
cuts operating costs,
reduces errors, and
ensures that commercials
go on-air correctly**

More than four years ago engineers of the Taft Broadcasting Company, under the direction of W. H. Hansher, Vice President, Engineering, began planning a new plant for their Cincinnati station, WKRC-TV. Their burning desire was to make the new station, not only the finest and most advanced in the industry, but also the most efficient and reliable. To attain the latter, they planned the world's first full-scale, full-time automated TV station installation.

Preliminary studies leading up to the actual planning extended over several years. During this period engineers of Taft Broadcasting studied various possible ways of building a system which would fit WKRC's needs. They investigated methods of accomplishing the necessary control and switching operations, and they tested circuit components to be sure they had the best solutions. With this background to go on, they wrote specifications for an automation system which was far in advance of anything previously in existence. After preliminary negotiations, RCA was chosen to build the equipment and from this point on engineers of the RCA Systems group worked hand in hand with engineers of Taft Broadcasting to build and install an automation system which is undoubtedly one of the industry's true pioneering advances.

Since January 4, 1960, when WKRC-TV first went on the air under automatic control, there has been a constant stream of visiting officials from other TV stations. The automatic programming tape, the remotely controlled cameras, and the operator-less film operation attract a great deal of attention. But of prime importance to station managers and owners is the increased efficiency of operation.

Engineers like the precision that this new approach makes possible. Its built-in accuracy affords a new solution to the age-old problem of human error. And the ability to prearrange switching operations avoids the tenseness of the station-break period.

Agencies and advertisers feel that this electronic control system relieves them of much of the headache of checking commercials. Smooth handling of clients' spots seems assured. Lost air time will become a thing of the past. In the words of one agency vice-president: "There are some things that machines do better than people".

economics of automation

There is no doubt that automation reduces expenses in the operating area. Fewer operators are required for such tasks as switching, camera control, and running projectors. Furthermore, machines make fewer mistakes than people. Finally, automation relieves the tension and strain that lead to errors.

On the other hand, the automation system does not bring unmixed benefits. It is to be expected that the maintenance load, for example, would increase. This would offset some of the savings in manpower.

At WKRC, the introduction of Automation resulted in reduction of technical staff from 23 to 10 men. It is conservatively estimated that no more than three of thirteen will be replaced, because of requirements in other areas. The dollar savings add up to a six figure total.

Of more consequence, of course, is the improvements in operations. Since WKRC estimates that 95 per cent of all errors are human errors, the increase in operating accuracy is somewhat tremendous.

frontiers

possibility:

WKRC estimates that automation will reduce errors as much as 95 per cent

95%
HUMAN
ERRORS

5% EQUIPMENT
ERRORS

STANDARD
OPERATION

5% EQUIPMENT
ERRORS

AUTOMATED
OPERATION

dollar savings at WKRC
run into six figures

STANDARD OPERATION

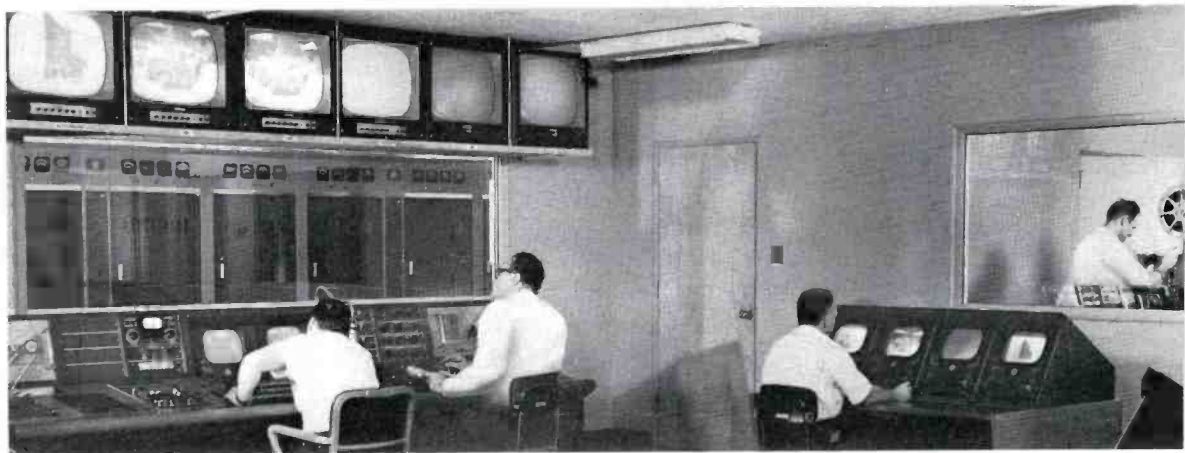

AUTOMATED OPERATION



advantages

advertisers like the accuracy of an automated station

control tape contains

makes possible unattended projection room

simplifies operations—helps prevent mistakes

helps freeze schedules

includes remote control for studio cameras

switches live shows and commercials

improves efficiency of all departments

fewer changes are made by clients

cuts operating costs

full-time system

There have been, before this, attempts to automate TV stations with varying degrees of success; however, most previous attempts have been confined to only a small fraction of the program day, namely, the station break periods. At WKRC, the automation schedule covers the entire program day. On the control tape are logged all programs and commercials from sign-on early in the morning to sign-off in the small hours of the following day!

switches live shows

Furthermore, previous attempts at automation were restricted to control of film and slide facilities, and for switching to and from the network. Local live shows were all handled manually. At WKRC, however, even live shows are switched by the electronic brain. Not only film and slide projectors but live cameras also are switched at the proper time according to the master clock and control tape signals.

controls all audio

In the audio area, the various sound sources are all controlled by the tape. These include: sound-on-film, announce booth, studio microphones, and tape recorders. They are all switched together with the proper video source as called for by the control tape.

Thus, this is a system that covers all of the station's needs. It operates over the entire program day. And it handles switching of all facilities, be they local or network, live or film.



switches TV tape
audio tape
and announce

controls audio
and video gain

data for operating station for 18 hour day

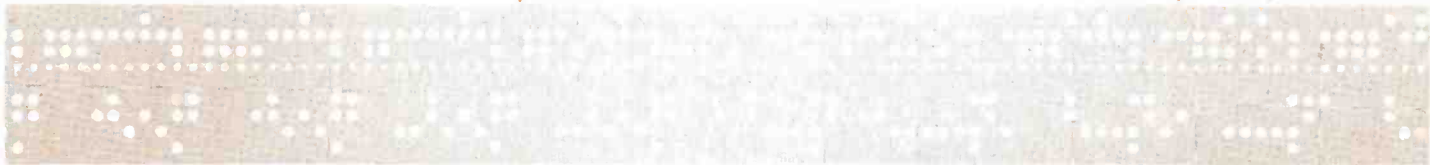

starts and stops
projectors

switches
films and slides

cues projectors

runs single prints
as multiple spots

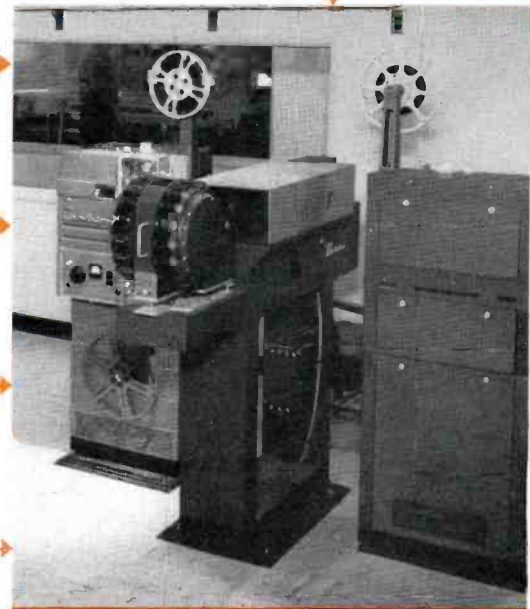

makes possible unattended
projection room



how automation control tape is produced

as schedule is being typed, the same information is punched on a paper tape



Program Order



Commercial Order

the automation system

The three elements of the automation system are: (1) the control tape, (2) the electronic brain, and (3) the master clock. Stated very simply, these three control the various equipments and switch the programs and commercials on air. It's all done at the proper second.

Here is how it is done. The control tape sends signals to the electronic brain by means of a special code. The Electronic Brain turns equipment on and off and switches program sources — by means of decoders and relays. The master clock supplies accurate time signals so that all commercials and programs are properly timed.

helps freeze schedule

Automation offers a distinct advantage to stations in firming of advertiser's programs. Those local clients who have a habit of dropping in, do not make as many frequent changes as they once did. Not only so, but it has been found that automation also helps the advertiser in preparing his schedule on time. So that he can check in advance, he prepares in advance.

elements of automation system

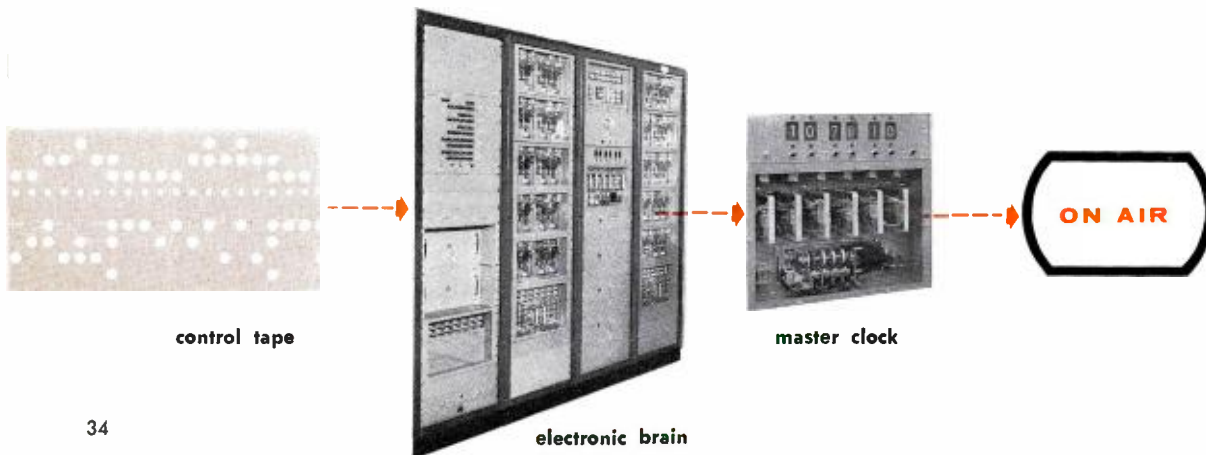



Traffic Director types schedule

WKRC-TV
EARLY SCHEDULE
LOG

TIME	SCHEDULED	PROGRAM AND SPOT/C	MODE	VIDEO	AUDIO	REMARKS
1	01:30:00	AS THE WORLD TURNS (P & G)	TV	TV		
2	01:31:00	Local Cutin: JCB (7/25/64)	50	44		
3	01:32:00	NEWS	TV	TV		
4	01:33:00	NEWS	TV	TV		
5	01:44:00	CAPT. BILL TELA (7/25-10-27)	30	44		
6	01:44:00	TELEVISION Then Film	10	44		
7	01:44:00	ID [Lone Guy Theatre]	40	44		
8	01:45:00	AS THE WORLD TURNS (FILLMORE KILLS)	TV	TV		
9	01:50:00	MTBL. BAKING CO.	30	44		
10	01:50:00	MTBL. BAKING CO.	40	44		
11	01:52:00	MTBL. BAKING CO.	40	44		
12	01:52:00	MTBL. BAKING CO.	40	44		
13	01:55:00	NEWS (7/25-9-8-15)	10	44		
14	01:55:00	ID (MURKIN)	40	44		
15	02:00:00	FOR REFLECTION (SINDERS)	TV	TV		
There is no 2:15 PM News						
16	02:15:00	FOR REFLECTION (SINDERS)	TV	TV		
17	02:20:00	ADOLE. MAID (7/25-11/2)	50	44		
18	02:29:00	ID (Full 11/2)	40	44		
19	02:30:00	HOUSEFURY (SINDERS)	TV	TV		
20	02:44:00	HOUSEFURY (SINDERS)	TV	TV		
21	02:44:00	HOUSEFURY (SINDERS)	TV	TV		
22	02:44:00	HOUSEFURY (SINDERS)	TV	TV		
23	02:44:00	HOUSEFURY (SINDERS)	TV	TV		
24	02:44:00	HOUSEFURY (SINDERS)	TV	TV		
25	02:44:00	HOUSEFURY (SINDERS)	TV	TV		
26	02:44:00	HOUSEFURY (SINDERS)	TV	TV		
27	02:44:00	HOUSEFURY (SINDERS)	TV	TV		
28	02:44:00	HOUSEFURY (SINDERS)	TV	TV		
29	02:44:00	HOUSEFURY (SINDERS)	TV	TV		
30	02:44:00	HOUSEFURY (SINDERS)	TV	TV		
31	02:44:00	HOUSEFURY (SINDERS)	TV	TV		
32	02:44:00	HOUSEFURY (SINDERS)	TV	TV		
33	02:44:00	HOUSEFURY (SINDERS)	TV	TV		
34	02:44:00	HOUSEFURY (SINDERS)	TV	TV		
35	02:44:00	HOUSEFURY (SINDERS)	TV	TV		
36	02:44:00	HOUSEFURY (SINDERS)	TV	TV		
37	02:44:00	HOUSEFURY (SINDERS)	TV	TV		
38	02:44:00	HOUSEFURY (SINDERS)	TV	TV		
39	02:44:00	HOUSEFURY (SINDERS)	TV	TV		
40	02:44:00	HOUSEFURY (SINDERS)	TV	TV		
41	02:44:00	HOUSEFURY (SINDERS)	TV	TV		
42	02:44:00	HOUSEFURY (SINDERS)	TV	TV		
43	02:44:00	HOUSEFURY (SINDERS)	TV	TV		
44	02:44:00	HOUSEFURY (SINDERS)	TV	TV		
45	02:44:00	HOUSEFURY (SINDERS)	TV	TV		
46	02:44:00	HOUSEFURY (SINDERS)	TV	TV		
47	02:44:00	HOUSEFURY (SINDERS)	TV	TV		
48	02:44:00	HOUSEFURY (SINDERS)	TV	TV		
49	02:44:00	HOUSEFURY (SINDERS)	TV	TV		
50	02:44:00	HOUSEFURY (SINDERS)	TV	TV		
51	02:44:00	HOUSEFURY (SINDERS)	TV	TV		
52	02:44:00	HOUSEFURY (SINDERS)	TV	TV		
53	02:44:00	HOUSEFURY (SINDERS)	TV	TV		
54	02:44:00	HOUSEFURY (SINDERS)	TV	TV		
55	02:44:00	HOUSEFURY (SINDERS)	TV	TV		
56	02:44:00	HOUSEFURY (SINDERS)	TV	TV		
57	02:44:00	HOUSEFURY (SINDERS)	TV	TV		
58	02:44:00	HOUSEFURY (SINDERS)	TV	TV		
59	02:44:00	HOUSEFURY (SINDERS)	TV	TV		
60	02:44:00	HOUSEFURY (SINDERS)	TV	TV		
61	02:44:00	HOUSEFURY (SINDERS)	TV	TV		
62	02:44:00	HOUSEFURY (SINDERS)	TV	TV		
63	02:44:00	HOUSEFURY (SINDERS)	TV	TV		
64	02:44:00	HOUSEFURY (SINDERS)	TV	TV		
65	02:44:00	HOUSEFURY (SINDERS)	TV	TV		
66	02:44:00	HOUSEFURY (SINDERS)	TV	TV		
67	02:44:00	HOUSEFURY (SINDERS)	TV	TV		
68	02:44:00	HOUSEFURY (SINDERS)	TV	TV		
69	02:44:00	HOUSEFURY (SINDERS)	TV	TV		
70	02:44:00	HOUSEFURY (SINDERS)	TV	TV		
71	02:44:00	HOUSEFURY (SINDERS)	TV	TV		
72	02:44:00	HOUSEFURY (SINDERS)	TV	TV		
73	02:44:00	HOUSEFURY (SINDERS)	TV	TV		
74	02:44:00	HOUSEFURY (SINDERS)	TV	TV		
75	02:44:00	HOUSEFURY (SINDERS)	TV	TV		
76	02:44:00	HOUSEFURY (SINDERS)	TV	TV		
77	02:44:00	HOUSEFURY (SINDERS)	TV	TV		
78	02:44:00	HOUSEFURY (SINDERS)	TV	TV		
79	02:44:00	HOUSEFURY (SINDERS)	TV	TV		
80	02:44:00	HOUSEFURY (SINDERS)	TV	TV		
81	02:44:00	HOUSEFURY (SINDERS)	TV	TV		
82	02:44:00	HOUSEFURY (SINDERS)	TV	TV		
83	02:44:00	HOUSEFURY (SINDERS)	TV	TV		
84	02:44:00	HOUSEFURY (SINDERS)	TV	TV		
85	02:44:00	HOUSEFURY (SINDERS)	TV	TV		
86	02:44:00	HOUSEFURY (SINDERS)	TV	TV		
87	02:44:00	HOUSEFURY (SINDERS)	TV	TV		
88	02:44:00	HOUSEFURY (SINDERS)	TV	TV		
89	02:44:00	HOUSEFURY (SINDERS)	TV	TV		
90	02:44:00	HOUSEFURY (SINDERS)	TV	TV		
91	02:44:00	HOUSEFURY (SINDERS)	TV	TV		
92	02:44:00	HOUSEFURY (SINDERS)	TV	TV		
93	02:44:00	HOUSEFURY (SINDERS)	TV	TV		
94	02:44:00	HOUSEFURY (SINDERS)	TV	TV		
95	02:44:00	HOUSEFURY (SINDERS)	TV	TV		
96	02:44:00	HOUSEFURY (SINDERS)	TV	TV		
97	02:44:00	HOUSEFURY (SINDERS)	TV	TV		
98	02:44:00	HOUSEFURY (SINDERS)	TV	TV		
99	02:44:00	HOUSEFURY (SINDERS)	TV	TV		
100	02:44:00	HOUSEFURY (SINDERS)	TV	TV		

Page of WKRC Schedule

control tape

In normal station procedure, a daily schedule is usually typed. This lists the programs and commercials, the scheduled time, and the video and audio sources. At WKRC-TV this schedule is typed on a machine called the Flexowriter.

As the operator is typing the schedule, the Flexowriter also actuates an RCA-designed device affectionately called "the magic box". This produces a narrow paper tape, punched according to a special code. This is the Control Tape. It is used for automatic control of the TV station.

The control tape contains lines of punched holes as shown in the accompanying illustration. Ten lines comprise one of the events on the schedule. Each line of holes has a meaning. Thus, the control tape contains information about: mode, time, video source and audio source.

Blow-up of Control Tape. Light area comprises one event on the schedule.

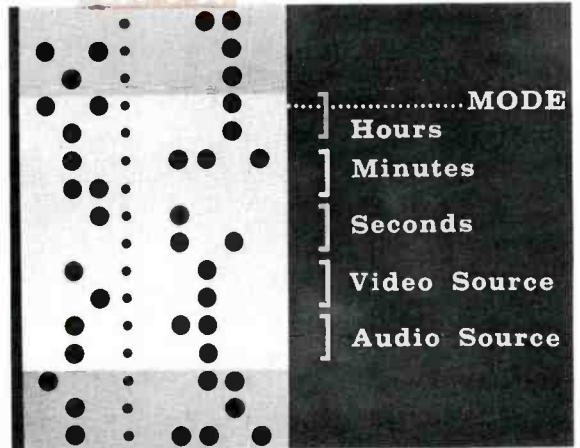

how the automation system works

Information on tape is fed to brain

The control tape contains in one small roll the data to guide all operations during the 18-hour day. This tape is placed on a "Tape Reader" in master control, prior to start of the day's programming.

The reader takes the information from ten lines (one event) at one time and passes it directly to the electronic brain. As each event is put on air, the reader "steps up" to the next event and puts it in the brain.

A second reader is included in the installation. This makes possible the use of a correction tape, when required. It is placed in the second reader and takes over operation at the proper time to insert changes. After corrections have been made, control is returned to the primary tape reader.

electronic brain stores and decodes information

Data received from the tape is stored in the electronic brain. Circuit paths are then set up to the specified video and audio sources. When the prescribed time is reached, the event is put on air.

In the WKRC installation, relays are used for storage of data. Information from the reader passes directly to stepping switches. These perform several functions, including decoding.

In the decoding operation, there are source decoders and time decoders. The source decoders cause source selector relays to set up circuit paths for switching slides, film, TV tape, turntables, live cameras, announce booth, and audio tape recorders. The time decoders supply signals for comparison with a master electronic clock to determine when time coincidence occurs.

eyes of the brain reveal what is happening

In each control area there is a wall mounted unit called the Readout Panel, which reads out (or displays) the information in the brain. It reveals two events: (1) the program on air and, (2) the upcoming event. Note in the accompanying illustration, that the following information is given: mode, time, video source, and audio source. The top line relates to the program that is on the air, and on this line, the seconds tick away to show elapsed time. The bottom line relates to the upcoming event, showing the time it is to go on air, and the sources for video and audio.

This information is useful to all operating personnel as well as program people. For this reason, readout panels are located in all control areas, announce booths, equipment and projector rooms, and on the floor of the studio. They tell operating personnel how much time until the next switch point. They tell program people how much time left until they go either on or off air.

As the event in the bottom (or preview) line reaches air time, the switch is made. Then the information on the top line disappears, and the information on the bottom line is transferred to the top line. At the same time, the control tape advances and the next event appears on the bottom line.

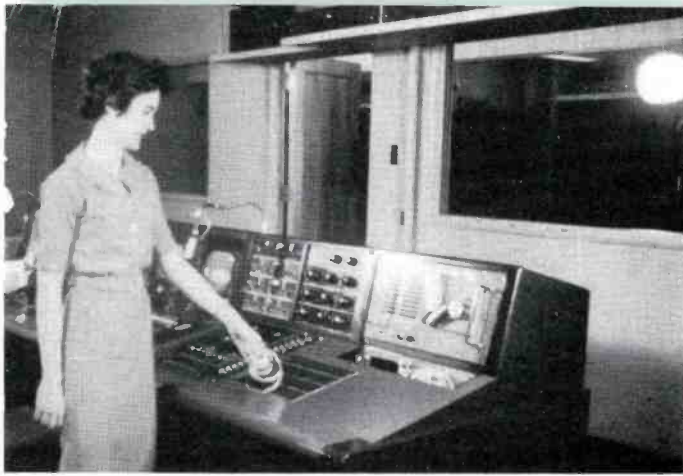

Control Tape is placed on Tape Reader (right).

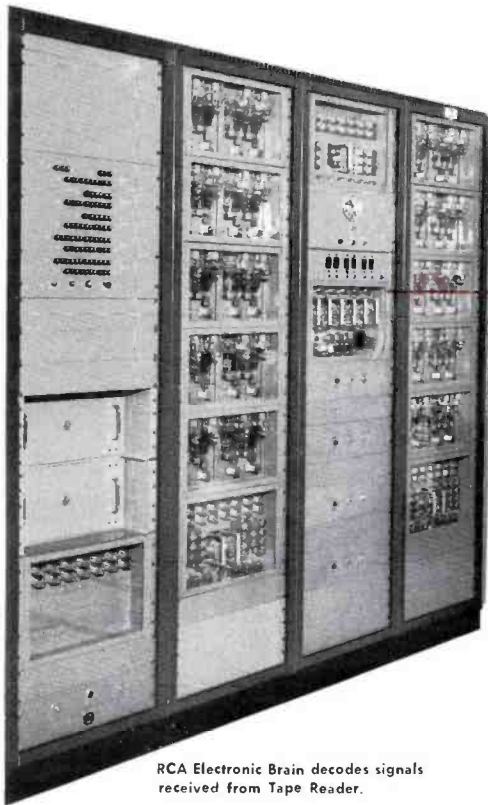

RCA Electronic Brain decodes signals received from Tape Reader.

Eyes of the brain show on-air program, and preview of next event.

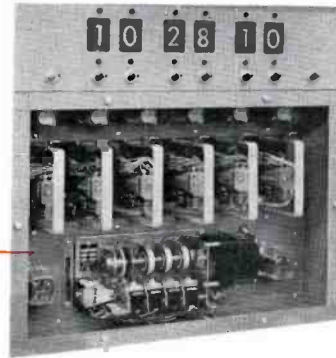
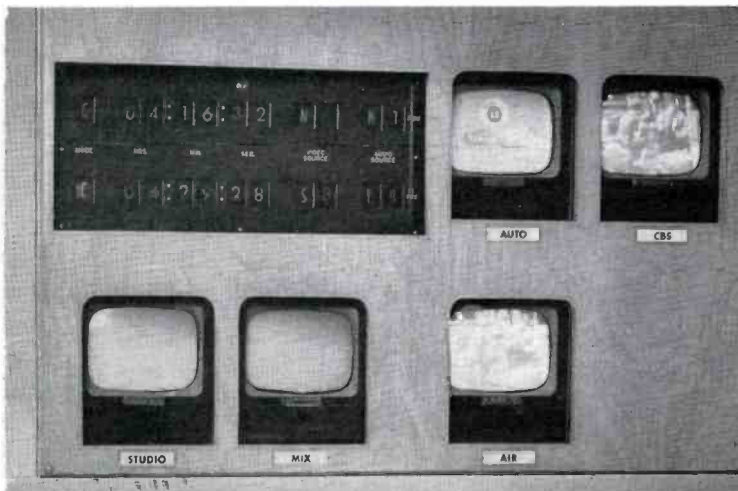

master clock times programs and commercials accurately

An electronic clock in the automation system is used to time the precise second that a switch is made to put a program or commercial on air. Events can be spaced as close as three seconds apart. The clock is very accurate, being timed by a tuning fork — in a temperature-controlled oven.

Signals from this clock also operate slave units which are mounted above the readout panels, to show the exact time. This time agrees with the time in the program line of the readout panel when in "C" (clock) mode. When in "A" (approximate) mode, the exact time and program time may not necessarily agree.

Signals from the master clock not only switch events according to the predetermined time, they also advance the control tape to the next event, so that the process is a continuing operation, as long as the system is in the "clock" or "approximate" mode of operation. Only a "manual" mode of operation can change this continuing procedure for automatic switching.

accommodates industry practices

The system was designed to accommodate conditions that exist in the industry. For example, some network breaks are scheduled at "approximately" such and such a time. Manifestly, it is impossible to program an "approximate" break completely automatically. Hence, there is provision made for "approximate time" method of operation.

At other times, it is desirable to take control manually. This may be necessary during certain live programs. It may also be useful when it is desired to lengthen or shorten a scheduled event. Hence, provision is also made for releasing the TV operation from automatic control and returning it to manual control — whenever desired. Furthermore, it is not unusual for a client to request rescheduling of a commercial. Although the control tapes are usually prepared 72 hours in advance, correction tapes can be inserted at any time before an event goes on the air.

Moreover, on occasion, it may be necessary to delete a scheduled event completely. This is usually a commercial or other short time event. This can be done by merely pushing the "by-pass" button. Then the scheduled event is eliminated.

advertisers like its accuracy

Visitors are greatly impressed at WKRC. Clients like the precision and accuracy with which their commercials are handled. Agency people predict a lot less supervision and checking of commercials.

Automation helps them to freeze schedules. Also clients do not make so many changes. Although changes can be made, there is less tendency to do so.

choice of three methods

C

CLOCK TIME

All Programs and Commercials Put on Air According to Sched- uled Time

Everything happens according to the master clock — all programs and commercials are put on air according to pre-determined times.

Operator Merely Supervises
— No Buttons to Push

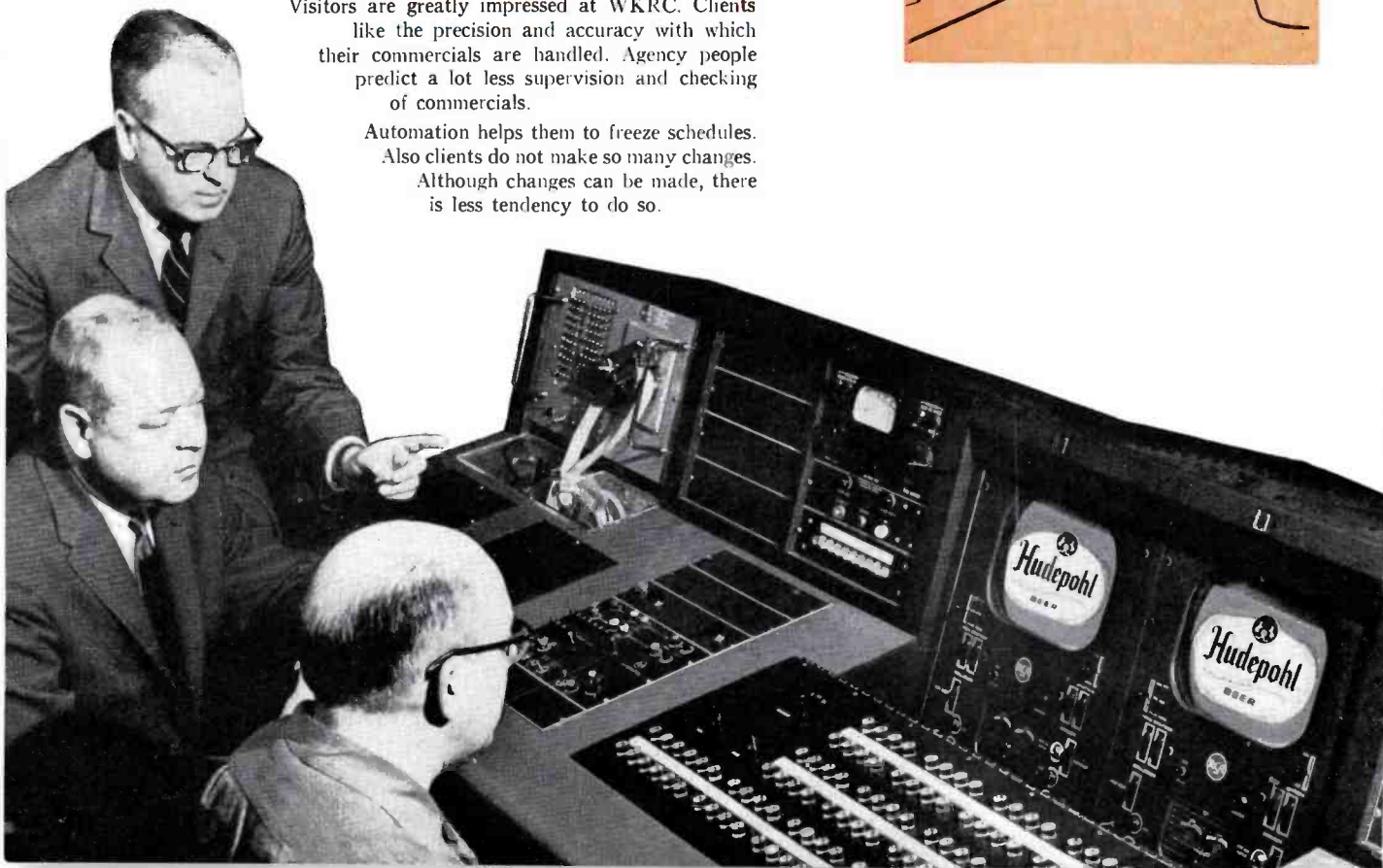
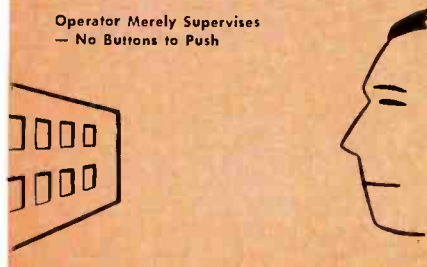

(or modes of operation) to accommodate industry practices

A

APPROXIMATE TIME

To Accommodate the Timing of Network Breaks

Operator pushes a button when cue is received — then all commercials are automatically put on air according to schedule.

1 Operation for a 2-Commercial 1-ID Break — rather than 19

approximate time

The approximate mode of operation is designed for breaks in network shows, when the exact time for the break is not known. The events to occur during this break are known, and the duration of each event is known, so that they can be entered on the schedule, and punched on the control tape. However, since the starting time for the break is only an approximate time, such a series of events must be started manually, upon receipt of network cue. Once started, they can proceed automatically until the switch back to network occurs.

Again only one button need be pushed by the operator to initiate the commercials during this break at an approximate time. It is not necessary for the operator to perform the numerous switching operations that complicate the routine of station operation during a program break.

M

MANUAL

When Desired to Lengthen or Shorten Events in the Schedule

Operator pushes a button for each event (commercial or program) — can time each event as desired. System acts like a pre-set switcher.

3 Operations for a 1-Commercial 1-ID Break — rather than 16

manual mode

Operation of the system as a pre-set switcher is possible. This relieves the operator of the great burden but retains manual control of timing. Also special effects can be inserted by the operator, specially for large live shows.

When the tape reaches a manual control point, the operator must push a button to initiate the next event. A flashing red button on the control panel (together with a flashing red light on the preview line of the readout panel), tell the operator that he must do something before the next event can go on air. It is not necessary for the operator to perform all the manual switching normally associated with a manual method of operation. It is only necessary to push the “operate” button, since the system acts as a pre-set switcher. In this area of simplifying operations automation makes its most important contribution.



robot

**STANDARD
OPERATION**



**AUTOMATED
OPERATION**

cameras and robot floorman

Weird is the sight in the studio as Skipper Rile puts on his show for the children. He is alone in the studio. Only silent stark pieces of equipment stare at him. Although unattended and without human hands to guide them, TV cameras follow every movement of the Skipper. At the same time an inanimate but extremely accurate readout panel blinks away the seconds, revealing to the Skipper exactly how much time is left until he is switched off air.

Thus, these robot cameras do everything that an attended camera can do. They pan right and left, or tilt up and down — as the action requires. A zoom lens is used to get dolly effects for close up, medium, and long shots. These effects are produced by the operator in the control room. He has a “joy stick” which he uses to control pan and tilt movements of the camera. Also a set of toggle switches to control the zoom lens.

A slave of the master clock is located in the studio to guide the talent timewise. It is mounted directly over a floor monitor. The clock has two rows of windows. The top row gives the exact time, ticking away in seconds. The bottom row gives the time that the next program is due on air. Thus, this unit acts as a robot floorman. The talent knows exactly when to begin, and also how much time is left to finish the show or commercial.



automation of live shows and commercials

These robot cameras and robot floorman are used to present live shows that do not require a great deal of production. Where no more than two live cameras and two microphones are used, this can be done. News and weather shows are typical. Also interviews, panels, and personality shows. All these have been successfully handled at WKRC. In addition, all live commercials are produced this way, both for rehearsal and for on air.

remote control of live cameras

On-the-air operation (as shown on facing page) shows talent facing manless cameras in studio. Before automation, this operation required three persons in the studio.

(left): Two studio cameras are remotely operated from master control.

(below): “Joy-Stick” is used for pan and tilt. Toggle switches are used for zooms and focus.



**innovations in film equipment
make possible
unattended projection room**

automation innovations

In preparation for the advent of electronic control of TV stations, RCA had been developing certain essential equipment devices. These would make film and slide projectors, turntables and recorders, all capable of automatic operation. These developments include: automatic light control, fast start, automatic cue, and continuous loop.

Automatic light control relieves the operator at the film camera, by providing self-compensation for areas in films and slides that are either too light or too dark.

Fast start enables the film projector to get up to operating speed within one second, in order to fit into the three second interval desired for automatic switching. Automatic cue makes it possible to make sure that when the projector stops, it will be in exact position to show the next event on the film.

**continuous loop serves local
advertisers needs**

Designed especially for WKRC-TV is a projector accessory capable of handling up to five minutes of 16mm film on a continuous loop. This is used for repeats of commercials, when only one print is supplied. It is a most convenient way of dealing with this vexing problem.

Local motion picture houses frequently supply a trailer, of which they have only one copy, to be run as much as ten times daily. Public services usually only have a single print available for showing (because of budget restrictions). In many cases, local advertisers are in the same position. It is here that the CLP enables a TV station to serve its clients' needs at a minimum cost .

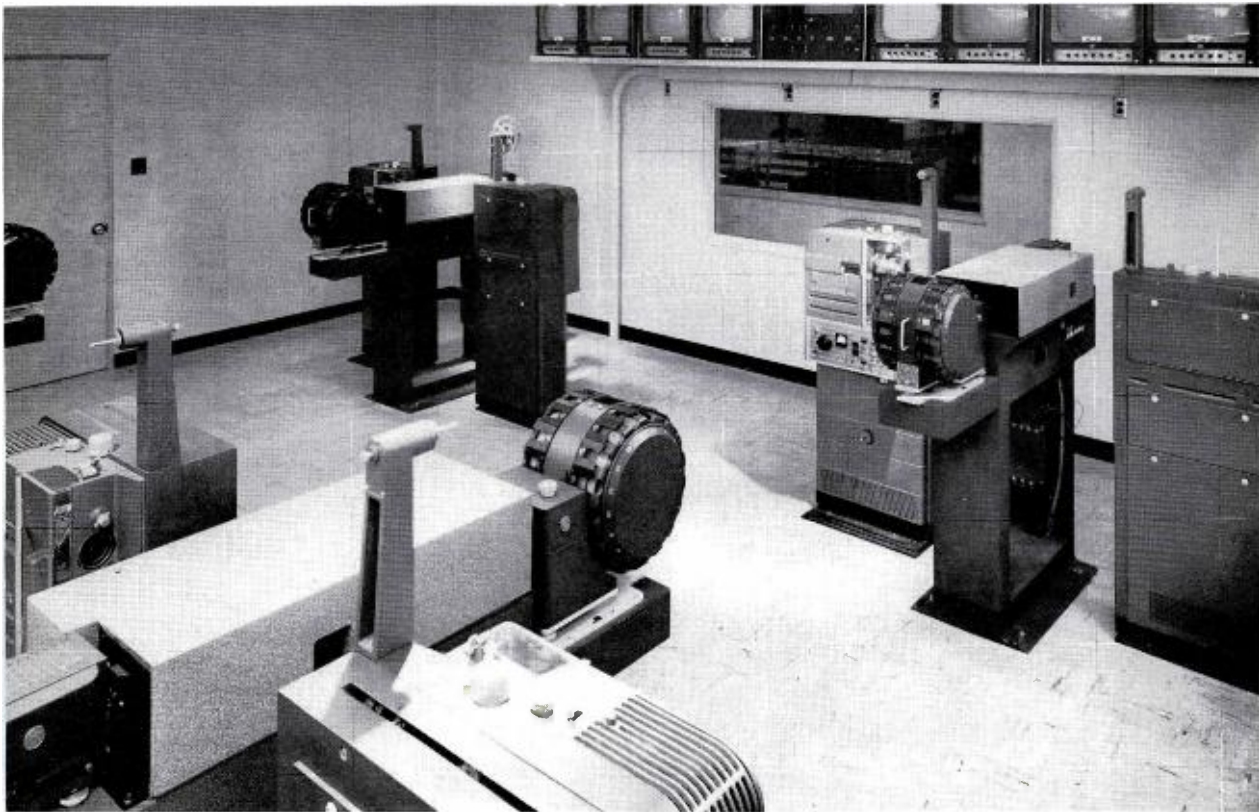

WKRC has facilities to handle films and slides for half of the normal 18-hr. day's programming.



Continuous Loop Projector makes possible multiple showing of single prints.

loading

Slides and films are loaded twice daily by engineer in charge.

fast start

Projector reaches operating speed within 1 second.

auto cue

Film cues up automatically on projector.

continuous loop

Special projector used for spots run several times from one print.

light control

Automatic light control provides uniform quality pictures for viewers.

features of WKRC-TV film room

design for automation

The WKRC system was designed according to operating requirements specified by the engineering staff of the Taft Broadcasting Company, owners of WKRC. Unlike previous systems, it operates over the entire program day. Further, it can switch live shows and commercials as well as film and slides. Thus, the system at WKRC represents not only the most complete but also the most advanced in the world today.

future systems

Similar systems can be designed for other television stations. Since each station has its own particular requirements, it becomes a matter of custom design. Some future systems may wish to include provisions for automation of paperwork — such as billing — as well as program control. Others may simply desire to automate for that intensely critical period of activity during station breaks. But all stations seek to use these most modern methods to attack the twin problems of rising operating costs and ever present human error. It is in this area — where 95 per cent of all errors occur — that an automation system serves its chief purpose.

improves product

Since it assures accuracy in switching, the electronic brain eliminates those human errors that cut short a commercial or otherwise give rise to a rebate or make good. In any event, automatic machinery can do some things better than people. As a result this machinery usually pays for itself in terms of savings and improved product.

In the area of broadcasting, it is likewise true that automatic operation can reduce costs of operation as well as improve programming. Rebates are reduced. Times of tension are eased or eliminated.

opens new era

Automation introduces television broadcasters to a new era. Through the magic of electronics much of the routine labor of man can be taken over by the machine. Hence, the broadcaster can have the time and facilities to concentrate on the more important things that only men can do.

WKRC installation includes new RCA transistor switching and special effects system



primary control tape

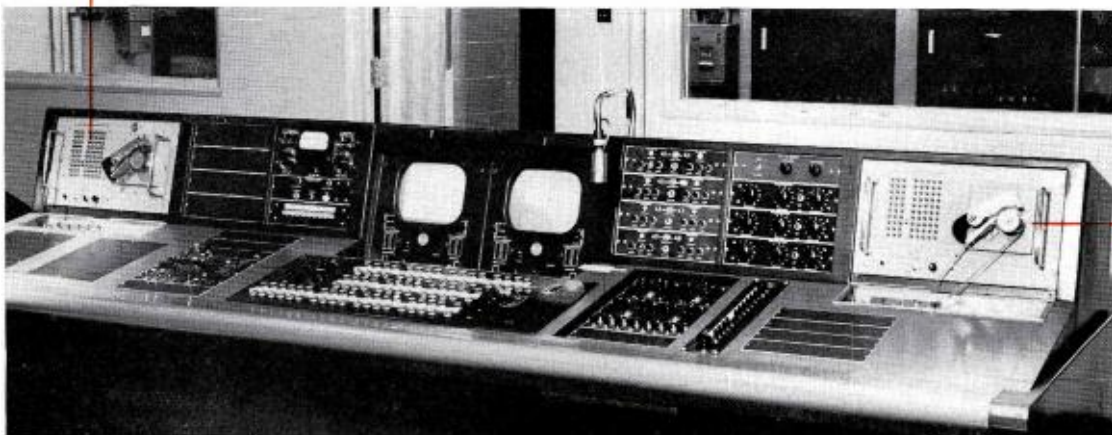

Master control includes provision for both primary control tape (left) and correction tape (right).

correction tape

10-WATT TRANSISTOR MONITOR AMPLIFIER

*New Compact Amplifier Offers High Fidelity Performance
With Very Low Distortion and Power Consumption*

A completely self-contained transistor monitor amplifier, the BA-34A requires only half the space and 30 percent of the power needed for an equivalent tube type amplifier. At the same time this new amplifier provides a full 10 watt output with excellent frequency response. It uses a multi-stage power amplifier circuit with negative feedback to achieve excellent frequency response and very low distortion. Thermistor control of the output stage idling current compensates for temperature changes. The high gain input of the BA-34A permits operation from low level microphones. A bridging control may be used in the input circuit.

Low Power Drain

The BA-34A monitor amplifier achieves a 60 percent power saving compared to the BA-24A tube type monitor amplifier. Only 25 watts are drawn by the BA-34A compared with the 70 watts required to operate the BA-24. Very low heat dissipation provides cool operation. The transistor power-supply of the BA-34A is protected by two fuses. Hum and noise levels in the BA-34A are kept down to -120 dbm referred to the input.

Unique Circuits

The low level two-stage pre-amplifier will accept inputs at microphone level at 37.7, 150, or 600 ohms. The pre-amplifier followed by a dual transistor phase splitter stages which in turn feed dual driver stages (see Fig. 2). The output stage uses dual class "B" amplifier stages with the transistors connected in an NPN-PNP arrangement to produce a push-pull output circuit. Three separate feedback paths help to keep distortion below one percent overall.

More Efficient

The new BA-34A Transistor Monitor Amplifier has a frequency response of ± 1.5 db from 30 to 15,000 cycles. Amplifier gain is 104 ± 2 db for 8 to 10 watt output. The overall performance of this compact transistor unit equals that of its equivalent tube type unit, yet it draws much less power and occupies half as much space. The BA-34A is the third unit to be added to the RCA line of amplifiers, and in the future more of these transistor units will be made available.

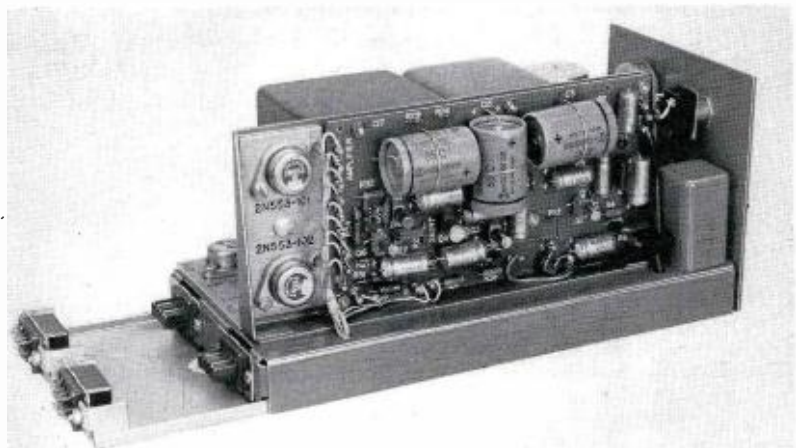

FIG. 1. The all transistor BA-34A Monitor Amplifier is easy to service and it features plug-in construction. The output transistors are mounted on circuit boards at the rear of the chassis.

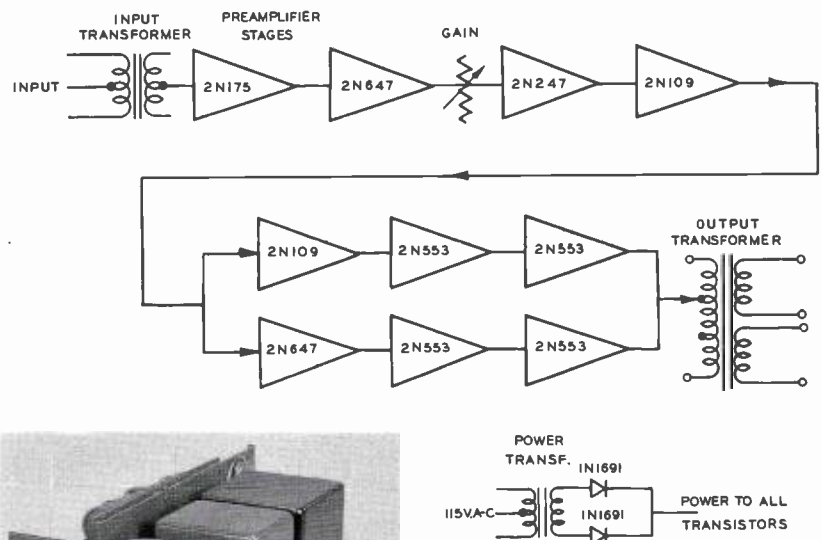

FIG. 2. This is a simplified block diagram of the BA-34A. Note the multi-stage output circuit.

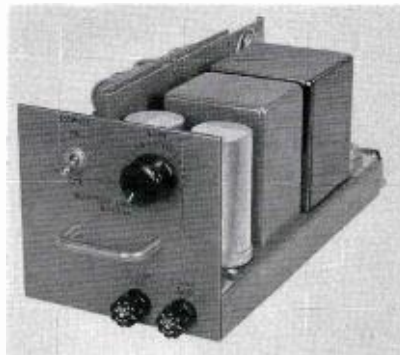

FIG. 3. The controls and fuses for the BA-34A are all mounted on the front panel as shown here.

NEW 1000 WATT FM TRANSMITTER

*Single Tube Design Produces An Inexpensive Unit
For Low Power Applications With Provisions
For Expanding To Higher Power*

by J. A. AURAND, Broadcast Transmitter Engineering

The new RCA BTF-1D FM transmitter was designed for both conventional and multiplex operation. It uses the standard BTF-10B Exciter* as its modulating and frequency control element. For simplicity of operation, it was desired to reduce the additional rf circuitry following the exciter to a minimum. The ideal solution was to use only one tube. By choosing the 4CX-1000A, a modern high-gain air cooled tetrode, a power gain of 200 including all circuit losses is achieved. This made it possible to eliminate intermediate stages and to resistance load the 4CX1000A input circuit for added stability. Further simplification is achieved in the control circuits and power supplies by using silicon diodes.

* "New FM Transmitter and Multiplex Equipment", *Broadcast News*, Vol. 102, October, 1958.

FIG. 2. The author is shown demonstrating the accessibility of the BTE-10B Exciter which tilts out for servicing.



Easily Accessible

Controls and meters are mounted on the vertical panel on the right side of the cabinet. Amplifier tuning controls, a multimeter, and the exciter controls are accessible through a non-interlocked front door (see Fig. 1). The exciter is mounted so it may be tilted out giving complete accessibility to all components (see Fig. 2). All other transmitter components are accessible from the back through an interlocked door.

Simplified Circuit

The output of the exciter is approximately 10 watts at the carrier frequency and is fed by 125-ohm coaxial cable to the input of the 4CX1000A amplifier tube (see Fig. 3). The amplifier input circuit is a simple parallel resonant circuit, tuned by a variable inductance with resistance swamping for stability of operation (see Fig. 4). This stage is neutralized by varying inductance in series with the screen. The output circuit is a modified pi network, having a variable inductance across the tube capacity—which is used to adjust the loading. All capacitors in the final stage are of the fixed ceramic type. A small blower on the back of the rf compartment provides sufficient filtered air for cooling the 4CX1000A for operation up to 7500 feet. The filament transformer is of the regulator type and keeps filament voltage regulation within one percent.

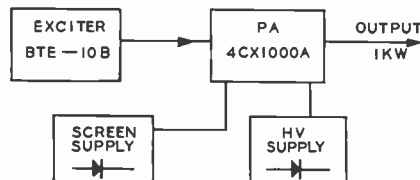

FIG. 3. This is a simplified block diagram of the BTF-1D. Note the simplicity of the entire transmitter including the silicon rectifier power supplies.

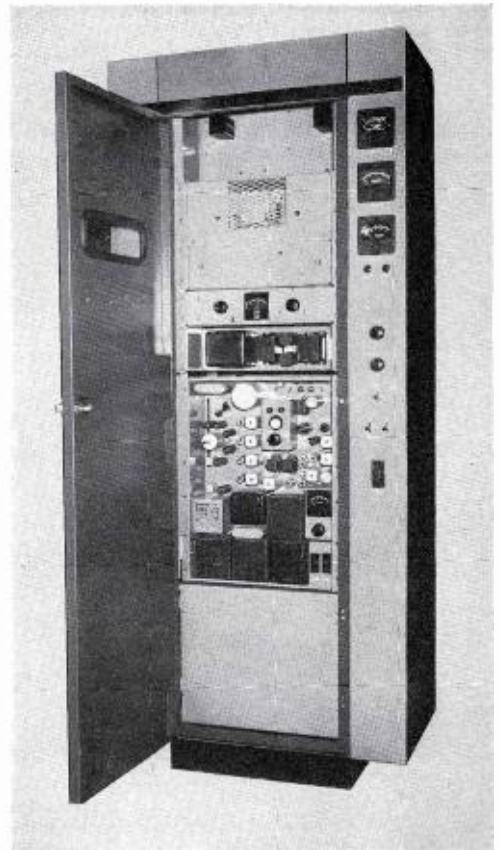

FIG. 1. A single cabinet houses the complete BTF-1D Transmitter. The 1 KW PA stage is mounted near the top of the cabinet with the BTE-10B Driver/Exciter below. Meters and operating controls are mounted on the right end panel.

Easy Neutralization

The 4CX1000A tube is designed to operate at maximum power without driving the grid into the positive region. A parallel resistor and diode combination in series with the grid bias lead prevents positive grid current during tuning but permits values of negative grid current without changing the fixed bias during normal operation (see Fig. 6). For tuning, this circuit provides the

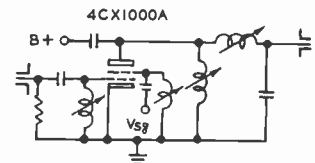

FIG. 4. This is a schematic of the PA stage showing parallel resonant input circuit and modified pi-network output. Neutralization adjustments are made with the variable screen inductor.



FIG. 5. The single 4CX1000A PA stage is shown here. The input and output tuning coils are shown on each side of the tube. The shield cover is easily removed to provide easy access to the stage, especially for tube replacement.

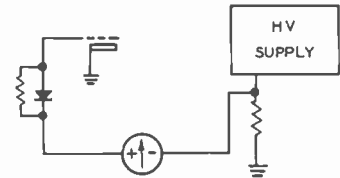

FIG. 6. A parallel resistor and diode combination, in series with the grid bias lead prevents positive grid current during tuning; however, it does permit negative grid current during normal operation without adjusting the fixed bias.

transmitter with means of adjusting the input circuit and neutralizing the 4CX1000A. Without plate or screen voltage, the drive from the exciter develops a voltage across the grid resistor, which is used for tuning of the input circuit and the exciter output.

The feedthrough power can also be measured by using a diode probe, which is supplied. Neutralization is completed by adjusting the screen inductance for a null on the multimeter. Operating bias is obtained from a resistor in the negative lead of the high-voltage power supply. The cathode can then be connected direct to ground and cathode bypasses eliminated.

Silicon Rectifiers

The high-voltage power supply uses a bridge circuit of silicon diode rectifiers (see Fig. 7). Each leg consists of 18 silicon diodes in series, each diode shunted by 27,000 ohms to insure equal voltage distribution. Printed circuit construction is used for each leg, making a unit with a peak inverse voltage rating of 7200 volts. This supplies more than ample safety factor when used in a 2700 volt supply. The screen silicon supply uses four diodes to supply the screen voltage for the 4CX1000A stage. A variable transformer in the primary of this

supply provides control of the screen voltage, which is used to control the power output of the transmitter.

Breaker Protection

Overload protection for the transmitter is supplied by a line circuit breaker and two overload relays in the ground leads of the two power supplies. These overload relays also protect the 4CX1000A tube, since it constitutes the total load for both supplies. The blower is protected by a thermal overload, and the tube by an air interlock. Only two fuses are used, both are in the crystal heater circuit.

Remote Control Provisions

The BTF-1D FM transmitter incorporates connections for remote control and remote meter reading, when combined with a remote control system such as the BTR-11B. To control transmitter power level remotely, an accessory motor drive may be connected to the screen supply control.

Furnished with the RCA harmonic filter, the BTF-1D meets current FCC and industry requirements with regard to spurious emission, cabinet, and harmonic radiation. Hence, this new unit is an excellent low-power, low-cost transmitter for both conventional and multiplex FM operation.

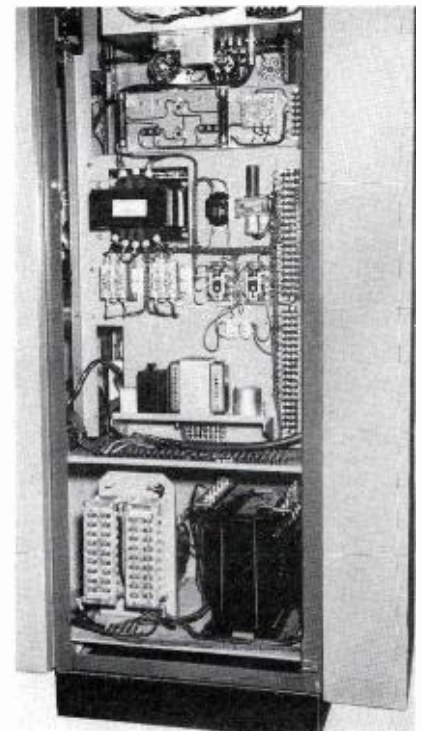

FIG. 7. In this rear view the silicon diode rectifiers are shown at the bottom of the cabinet next to the plate transformer. Two legs of 18 series diodes are used, and each is shunted by a 27,000 ohm resistor for equal voltage distribution.

NEW 10-KW FM TRANSMITTER

**Only Two Tubes Beyond Exciter
Reduces Operating Costs and
Produces a Compact High-Power
FM Transmitter**

by A. H. BOTT,
Broadcast Transmitter Engineering

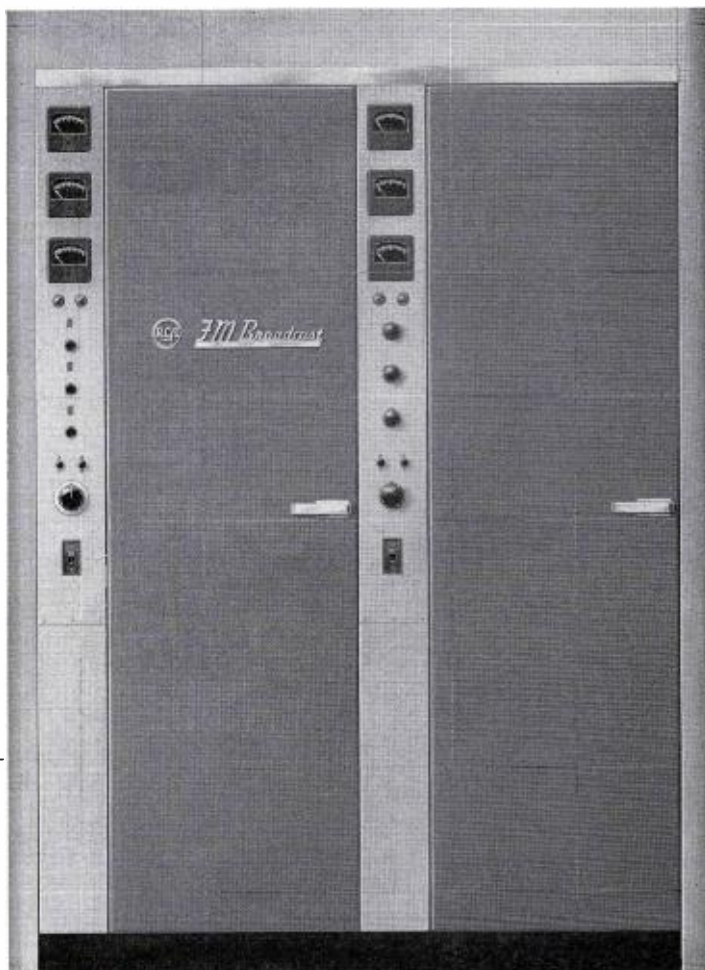

FIG. 1. Two compact cabinets house the 10 KW BTF-10C. Operating controls and meters are mounted on the front panels.

Designed for multiplex and conventional operation at a full 10 kw output, the BTF-10C FM Transmitter represents the latest in transmitter design. Only two tubes are used beyond the exciter, the IPA and PA, for greater circuit simplicity. The compact two cabinet transmitter has ample space provided for mounting either a BTX-1A Subcarrier Generator or the BTR-11A/20A Remote Control Equipment. When the BTF-10C is used with the BFA series of

¹ New 5 KW FM Transmitter, *Broadcast News*, Vol. No. 103, March, 1959.

FM antennas ERP's up to 120 kw can easily be obtained.

Compact Exciter

The standard BTE-10B FM Exciter is used in the new BTF-10C Transmitter as it is in every other recent RCA FM Transmitter. The exciter is completely self-contained including its own power supply. Its direct FM system assures full fidelity operation for both conventional and multiplex operation. The BTE-10B, when combined with necessary subcarrier generators, is

ideal for multiplexing, and its crosstalk level is very low.

The tilt-out unit is completely accessible, and it has a built-in multimeter and oscilloscope to permit rapid tune-up. Output of the BTE-10B Exciter is approximately 10 watts at the final frequency which provides adequate drive for the IPA stage.

Tetrode IPA Stage

The exciter drives a single 7034 IPA stage which produces 250 watts of driving power. Located in a shielded compartment

above the exciter, the IPA stage is completely accessible, and tuning does not require removal of the cover. Input and output networks of this stage are conventional pi-networks with variable capacitors as the matching components. Tuning from 88 to 108 mc is achieved by varying the inductance in the pi-network, which is accomplished by insertion of a silver-plated brass slug into the center of the coil (see Figs. 5 and 6). This IPA stage does not require neutralization for operation throughout the FM band.

Plate voltage for the IPA is obtained from the center tap of the PA power supply. A variable screen voltage supply is used on both PA and IPA stages to control power output. The IPA is protected by overload relays in the cathode circuit. Air interlocks are also provided to remove plate and screen voltage if cooling air flow should stop.

Simplified PA

The input of the PA is a modified pi-network in which the input capacity of the tube is shunted by an inductive line to reduce the effective input capacity of the stage (see Fig. 4). This inductance is also used to vary input loading. A capacity in parallel with the coil varies the inductive component of the circuit.

Plate loading and tuning are achieved by variation of two inductive line components in a pi-network arrangement. Tube capacity is shunted by the variable inductor (see Fig. 7). The pi-network has been inverted for mechanical simplicity and this results in grounding one end of the inductance. This eliminates the problem of insulating the variable component from ground: however, the output line must be parallel to the inductance to bring it to ground potential. This is done by extending the output line down one side of the inductive line.

PA Tuning

Initial tuning is made by approximate setting of all variable components according to a tuning curve. Final tuning is made under reduced plate and screen voltage for circuit protection. The PA stage is neutralized by variation of the inductance in series with the screen supply. Tuning across the 88 to 108 mc FM band required changing of only one frequency determining part in the PA input circuit.

Complete Protection

The control circuit provides a starting sequence which prevents application of plate voltage before filaments are warmed up and the blower is operating. It also pro-

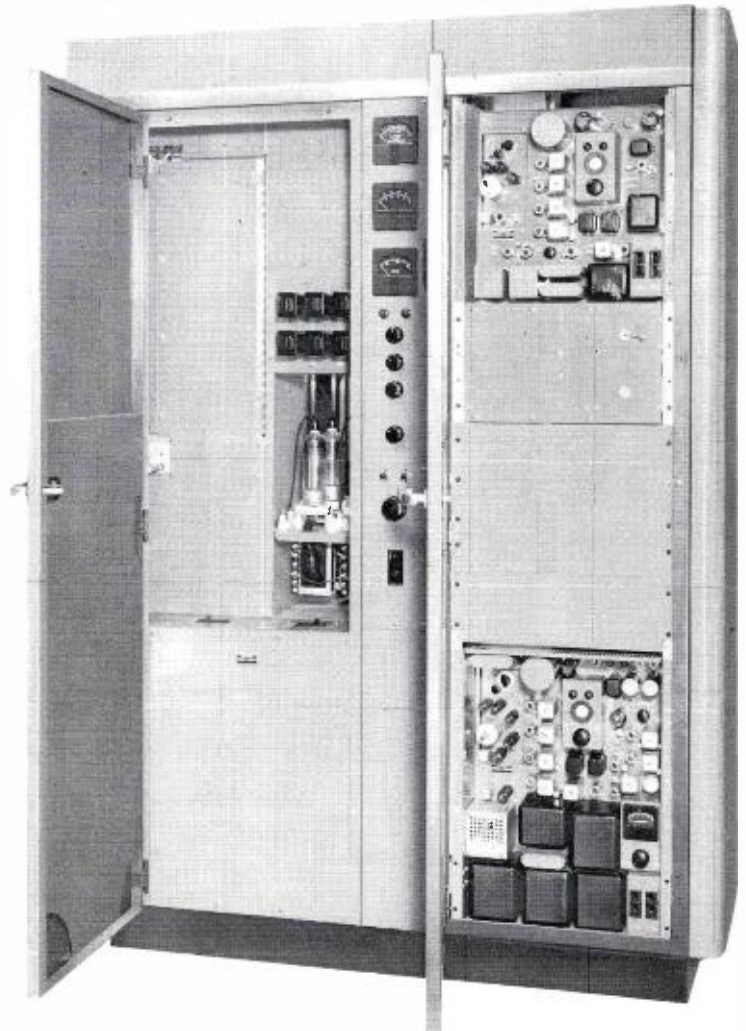

FIG. 2. With doors open access to all stages is easy. The large cubicle on the left contains the PA stage, rectifiers, and the blower. On the right, the exciter and IPA stages are accessible through a non-interlocked door. The BTE-10B Exciter is mounted at the bottom of the right cabinet and the BTX-1A subcarrier generator has been mounted in the upper portion.

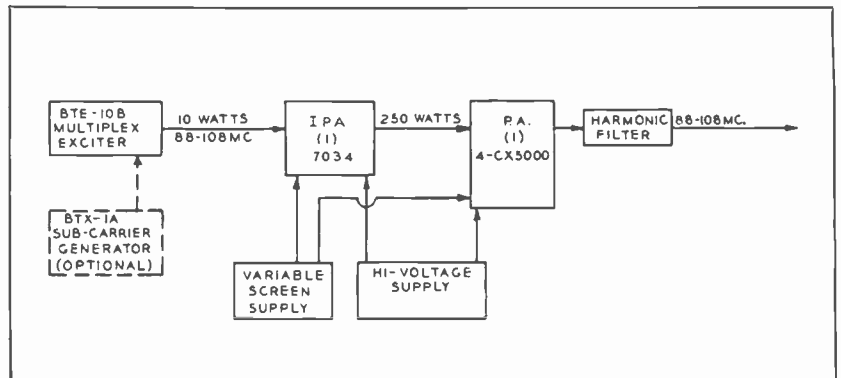

FIG. 3. This is a simplified block diagram of the BTF-10C. Note that only two single ended RF stages follow the exciter.

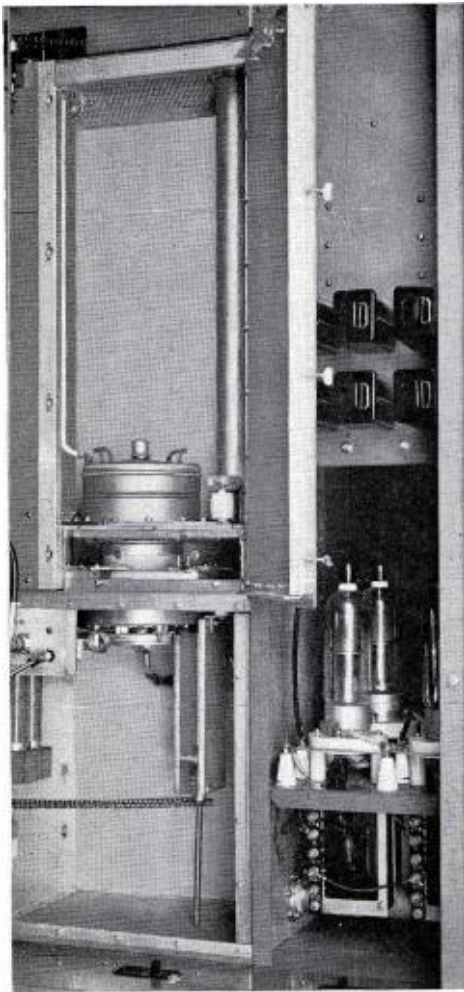

FIG. 4. Here the PA cavity is shown with the 4CX5000A tube in place. The rectifiers can be seen at the right.

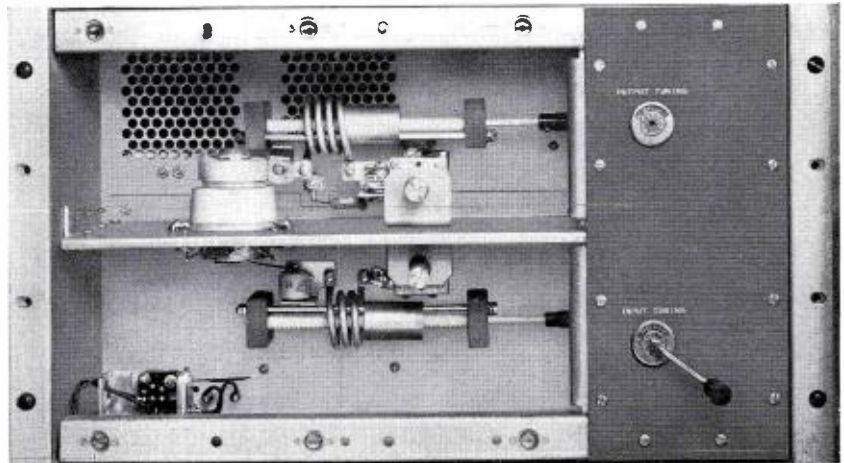

FIG. 5. This is the IPA stage compartment. Both input and output tuning controls are shown.

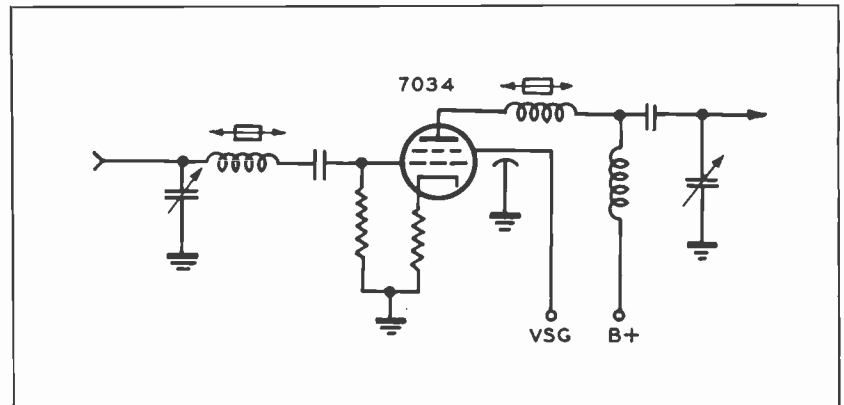

FIG. 6. Simplified schematic of the 7034 IPA stage. The slug-tuned input and output pi-networks provide frequency variation across the FM band without neutralization.

vides overload protection and off-frequency shut-down. Warm-up time of the exciter and filaments is controlled by a 45-second time delay relay. The overload circuit returns the transmitter to the air on the first two overloads after a clearing time of two seconds. On the third overload resetting is manual. The cathode circuits of the IPA and PA as well as the screen supplies and rectifiers are protected by overload relays. For remote control of the transmitter the necessary control and metering leads are made available at terminals located in the rear of the cabinet.

Power Supplies

This high voltage supply is a 3-phase full-wave circuit using six 8008 mercury

vapor rectifier tubes. A single-section inductive input filter produces 6200 volts at approximately 2.3 amperes to supply the plate of the 4CX5000A tube. The center tap voltage of the transformer supplies the 7034 plate through a double section RC filter, which filters and reduces the voltage to approximately 1800 volts. The screen voltage supply uses germanium rectifiers in a bridge circuit to feed both stages. The primary of this transformer is supplied from a variable transformer to control its output voltage.

Direct Air Cooling

Three-phase power is applied to the transmitter at the line breaker located on the right-hand front panel of the 10 kw

cabinet. Power is then fed to three other breakers: the first supplies power to the filaments, exciter and control circuit; the second, to the high-voltage supply; and the third, to the screen supply.

The *filament on* switch applies power to the blower, and also to the filaments, and exciter provided the blower is operating. The filament line passes through a buck-boost circuit so that it may be adjusted to the exact voltage for which the primary filament transformer taps are set. The 45-second time-delay relay is also energized which prevents application of the high voltage before the time-delay contacts close and all door interlocks are closed. This is indicated by the lighting of the ready light on the front panel.

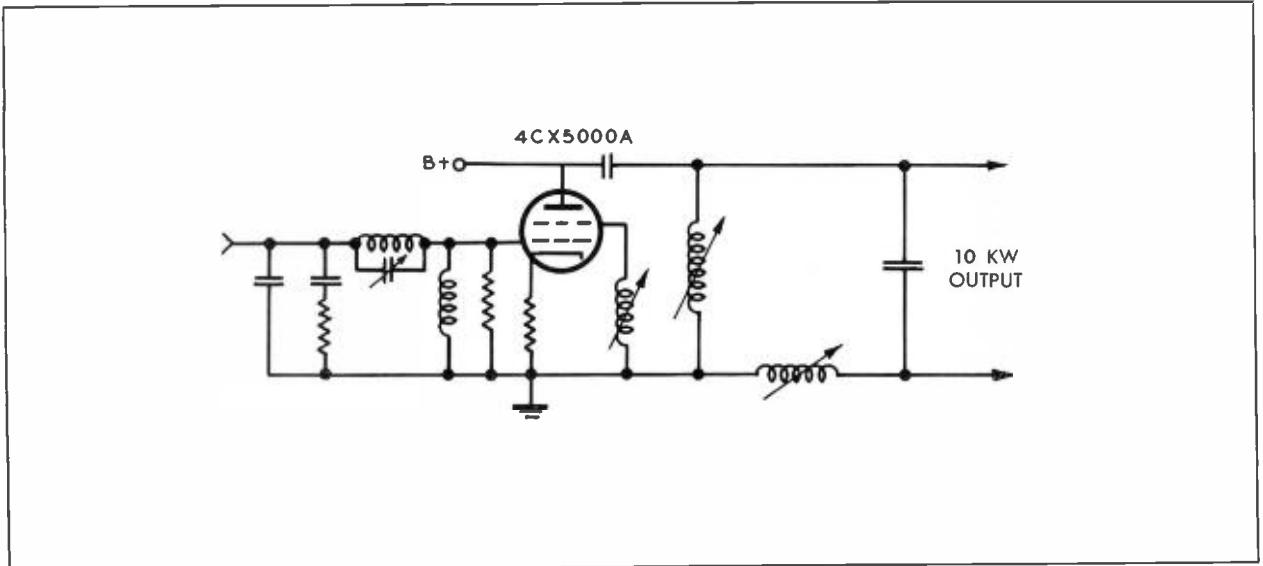

FIG. 7. This is a simplified schematic of the PA. The inverted pi-network output uses two variable inductors to control loading and tuning. The input pi-network is shunted by an inductive line to reduce input capacity.

FIG. 8. A third cabinet can be added to the BTF-10C to house another subcarrier generator, input and monitoring equipment or any other associated equipment. With the third accessory cabinet the BTF-10C remains very compact, yet it offers greater operating convenience.

The *transmitter on* switch applies the plate and screen voltage to the two tetrode stages. This is indicated by the lighting of the *transmitter on* light. A motor-controlled variable transformer in the screen-supply line adjusts the screen voltage by means of the *power adjust* switch.

The cooling system blower is located in the bottom of the 10 kw cabinet, feeding air directly into the 4CX5000A stage. The air for the 7034 stage is tapped off the side of the 4CX5000A box by means of flexible tubing feeding through the side of the cabinet. Air interlocks are provided in both stages to remove plate and screen voltage if the cooling air should stop.

Complete FM System

Coupled with RCA's new broadband FM antennas,² the BTF-10C Transmitter can provide effective radiated powers from 8 to 120 kw. Supplied with RCA's standard harmonic filter, the entire chain meets all current FCC and industry standards, including the new requirements on spurious emissions, cabinet radiation, and harmonic radiation.

² "New Broadband FM Antennas". *Broadcast News*, Vol. No. 101, August, 1958.

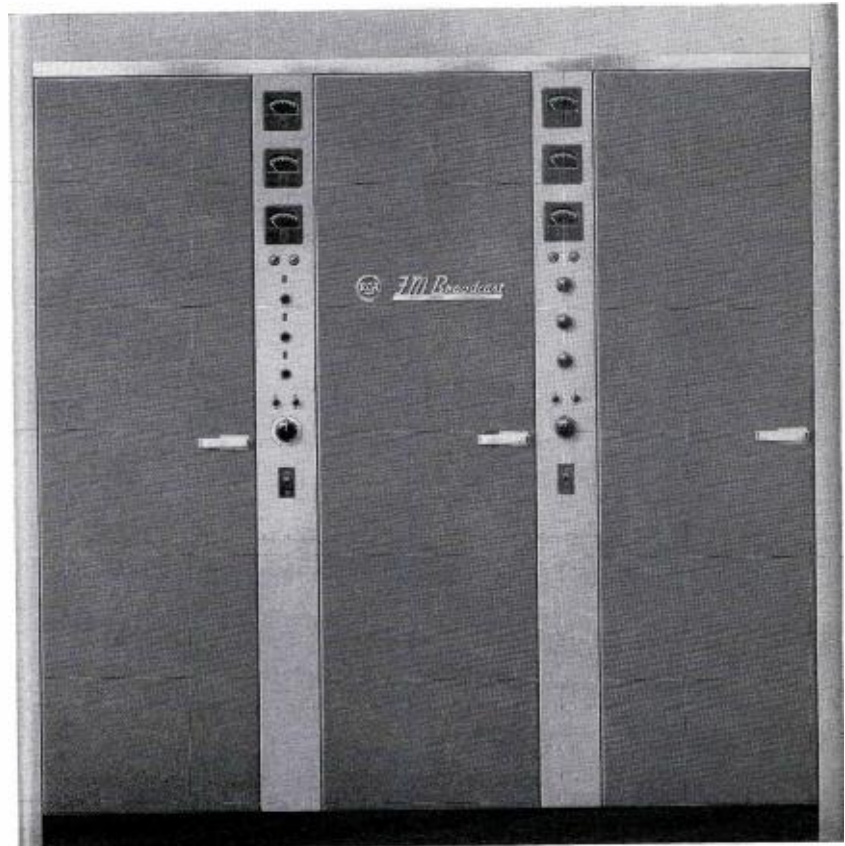

MEASURING TECHNIQUES FOR FM MAIN AND SUBCARRIER DEVIATION

Communications Receiver and Audio Oscillator Used to Make Easy Adjustments for Reducing Crosstalk

by I. H. LUBASH,
Broadcast Product Administration

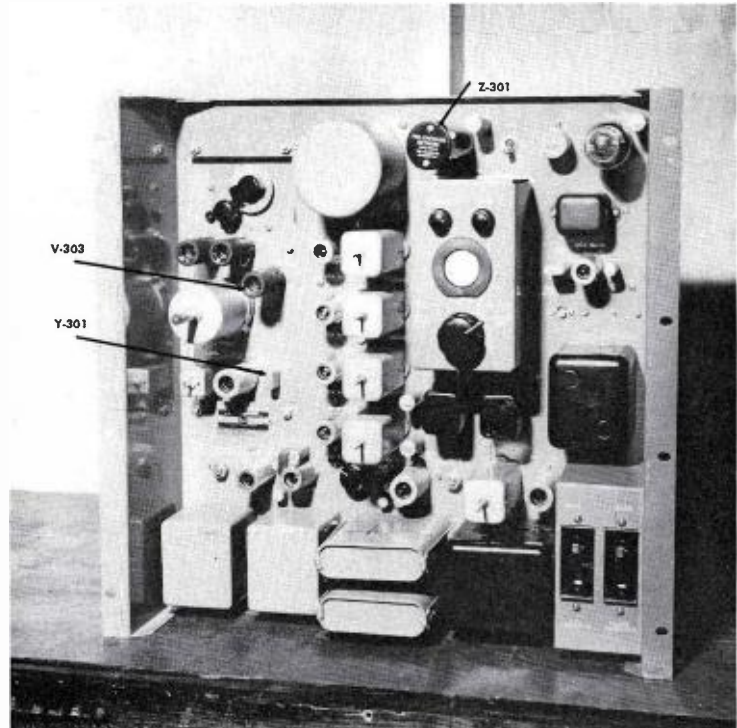

FIG. 1. This is the BTX-1A Subcarrier Generator. The receiver antenna lead is inserted between V-303 and its shield. The crystal Y-301 is removed. After calibrating the receiver the audio is applied through the input jack on the rear of the chassis.

Upon installation of one or more subcarrier generators such as the RCA BTX-1A, the FM station engineer is confronted with the problem of determining the proper adjustment for obtaining the desired deviation of the subcarrier. In addition, the deviation of the main channel by the subcarrier must be established. The simplicity of the following measuring techniques will make it easier to keep multiplex receivers operating properly.

Equipment Required

1. Communications Receiver with crystal filter or comparable selectivity.
2. Audio Oscillator with 50 to 15,000 cycle range.

Measuring Subcarrier Deviation

1. Place the communications receiver next to the BTX-1A Subcarrier Generator, and run a shielded lead from the receiver antenna terminal to a position between tube V-303 and its shield (Fig. 1).
2. Remove the subcarrier crystal (Y-301) and apply power to the BTX-1A.

3. Tune the receiver to 4680 kc. Switch in the receiver's crystal filter and turn on the BFO. (The BFO should be peaked on the unmodulated carrier.) The oscillator in the BTX-1A is accurate, and this can be used to calibrate the receiver for 4680 kc.
4. The pre-emphasis filter (Z-301) should be in place and be set for a 600-ohm input.
5. Set the audio oscillator at 3100 cycles and feed the output into the audio input jack (J-301) on the rear of the BTX-1A.
6. Increase modulation from the audio oscillator until the carrier signal disappears at the receiver. This represents a ± 7.5 kc frequency deviation. Increasing modulation beyond this point will result in the reappearance of the carrier tone.
7. Read the audio input voltage at the audio input jack (J-301). The voltage should be $+5\text{dbm} \pm 2\text{db}$, (this is equivalent to a voltage of 1.1 to 1.75 v. across J-301). To produce the same

deviation with a 400-cycle signal the input should be approximately $+10\text{dbm}$ or, more precisely, the 3100-cycle value plus 5db, (1.95 to 3.1 v.)

When frequency deviations other than ± 7.5 kc are used the audio input frequency will vary in accordance with this formula:

$$f_{\text{input}} = \frac{\text{deviation (kc)}}{m}$$

For example, a ± 15 kc deviation can be calculated as follows:

$$f_{\text{input}} = \frac{15 \text{ kc}}{2.4} = 6.2 \text{ kc}$$

Thus a 6.2 kc audio input signal is required.

The carrier disappears for the first time when $m=2.4$, because 2.4 is the first null of the Bessel function of the first kind, zero order.

After completion of the measurements replace the crystal, and the BTX-1A is ready for normal operation.

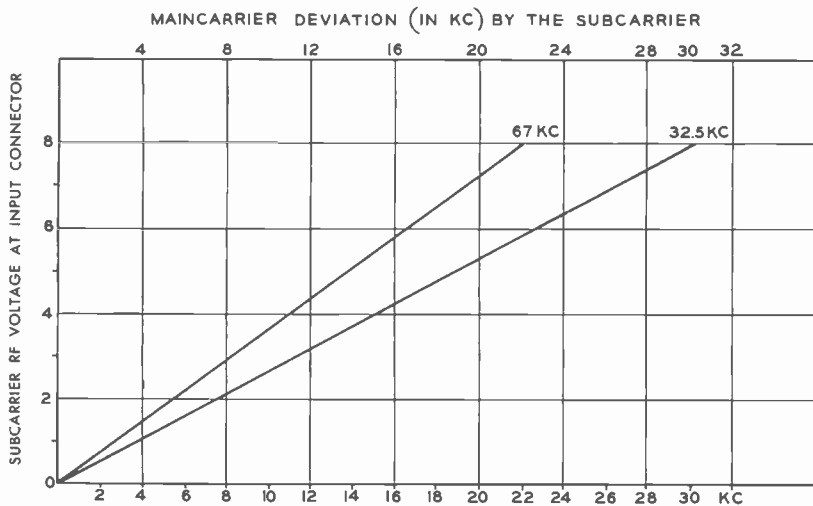

FIG. 2. This chart indicates the amount of subcarrier voltage necessary at the input of the BTE-10B Exciter to produce a specific frequency deviation.

Measuring Main Carrier Deviation By The Subcarrier

Approximate deviation of the main carrier can be measured without a monitor, using only a subcarrier generator and the chart shown in Fig. 2. The chart indicates the amount of subcarrier voltage necessary at the input of the BTE-10B Exciter (J-102 or J-106) to produce the required deviation.

As indicated on the chart, the higher subcarrier frequencies require slightly more voltage than the lower frequencies. To obtain a ± 10 kc deviation of the main carrier at 67 kc, 3.6 volts should be selected. At a 32.5 kc, 2.6 volts will produce the same main channel deviation.

The above method is approximate and subject to tolerances in the order of ± 25 percent. It is recommended that the reactance tube V-104 be compared with 2 or 3 other 6CL6 tubes. One method of doing so is by measuring relative subcarrier voltage. A multiplex receiver (with main program off) should produce a voltage of 0.1 to 0.2 volts at the discriminator with ± 15 kc deviation of the main by the subcarrier. Using several 6CL6 tubes this voltage should remain the same.

Proper setting of L-104 (see Fig. 3) in the BTE-10B (maximum grid current into the 2nd tripler) will coincide with minimum subcarrier deviation of the main channel. Detuning of L-104 will increase crosstalk as well as subcarrier deviation of the main carrier. Therefore, L-104 should be set to maximum grid current into the following tripler stage for minimum crosstalk.

These simplified measuring methods should aid the broadcaster now transmitting subchannels and make it easier to keep multiplex receivers operating properly.

The author wishes to thank Mr. A. H. Bott for his assistance in preparing this article.

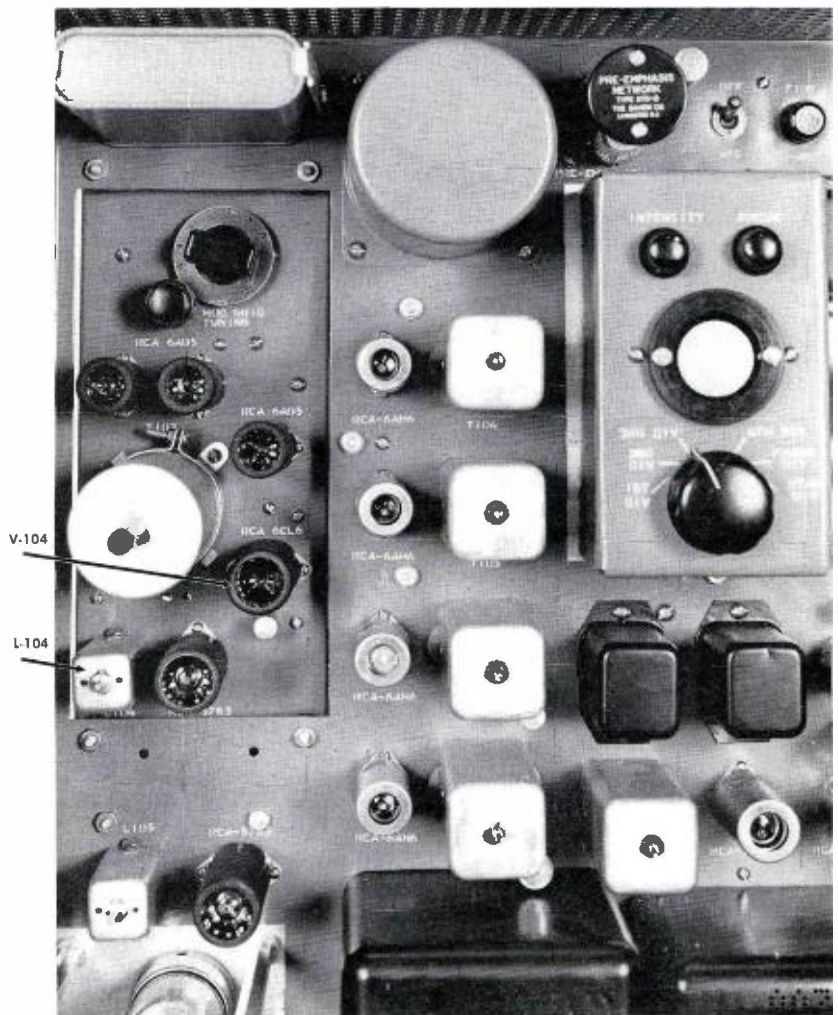

FIG. 3. The BTE-10B Exciter is shown here. The reactance tube V-104 should be compared with several other tubes of the same type, and very little change in deviation should be noted. L-104 should be set for maximum grid current into the tripler stage for minimum crosstalk.



FIG. 1. This is the new BK-11A Velocity Microphone mounted on an inexpensive desk stand. The attractively styled unit retains the familiar characteristic shape of the bi-directional ribbon microphone.

NEW VELOCITY MICROPHONE TYPE BK-11A

*Inexpensive Ribbon Microphone,
Incorporating Modern Improvements
For Full-Fidelity Broadcasting*

Attractively styled, the new BK-11A microphone is the modern equivalent of the famous 44-BX and Junior Velocity microphones. For many years, these famous instruments were standards throughout the broadcasting industry. Now the all-new BK-11A offers all of their advantages plus the latest developments in microphone design.

Bi-Directional Pattern

The dependable BK-11A microphone has a uniform frequency response from 30 to 15,000 cycles (see Fig. 2). Its bi-directional, figure-eight pattern permits placing of performers on both sides of the microphone, yet reflection pickup from side walls is greatly reduced (see Fig. 3).

The BK-11A is a general purpose microphone, offering excellent performance for both speech and music. Its frequency range makes it ideal for music pickup. A three-position, voice-music switch provides selection of the most desirable operating characteristics.

Compact Size

The attractively-styled, rugged shell of the BK-11A houses the familiar suspended ribbon that freely vibrates between the poles of a permanent magnet. Because of its lightness, the motion of the metallic ribbon corresponds exactly to the velocity of

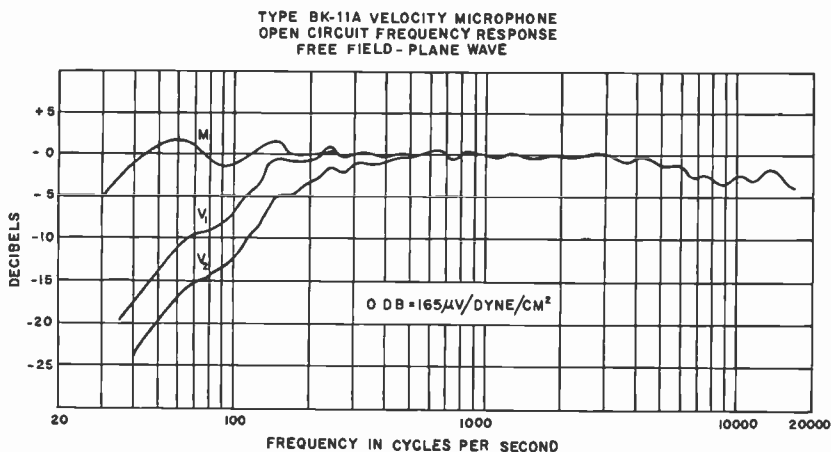

FIG. 2. Three operating ranges are easily selected for specific conditions, and these effect only the low frequency response of the BK-11A. Excellent overall response makes this microphone ideal for general purpose applications. The effective output level of the BK-11A is -56dbm at 1000 cycles.

the air particles. Therefore, the voltage generated by ribbon motion produces a faithful reproduction of the sound waves causing its motion.

Air flow through this microphone is free because it has no diaphragm. Thus, it is not subject to the effects of cavity resonance and pressure doubling.

Hum Shielding

The BK-11A is well shielded against stray magnetic fields, hence it will operate satisfactorily in areas of high hum level. Hum level pickup averages -130 dbm in the middle range of frequencies. Within the

microphone, extra shielding is used on the impedance matching transformers for added hum reduction.

Every possible precaution has been taken to isolate the sensitive ribbon from stray hum pickup. Stainless steel screens, front and back, protect the microphone element from mechanical injury. Special internal isolation between the element and case of the BK-11A eliminate the need for rubber shock mounting.

Inexpensive Mounting

Swivel shaft mounting of the BK-11A permits a 45-degree forward or backward

tilt. It can be conveniently used with the RCA MI-11008 and MI-4092E desk stands (see Fig. 1). In fact, it can be used with any type $\frac{1}{2}$ -inch pipe-thread desk or floor stand.

The new BK-11A was designed by RCA to fill the need for a dependable, general purpose, broadcast microphone. Its light-weight will make it ideal for indoor remote broadcasts, and its wide range frequency response makes it an excellent microphone for musical pickup. In normal studio use, it will offer high fidelity performance and a long life of rugged service.

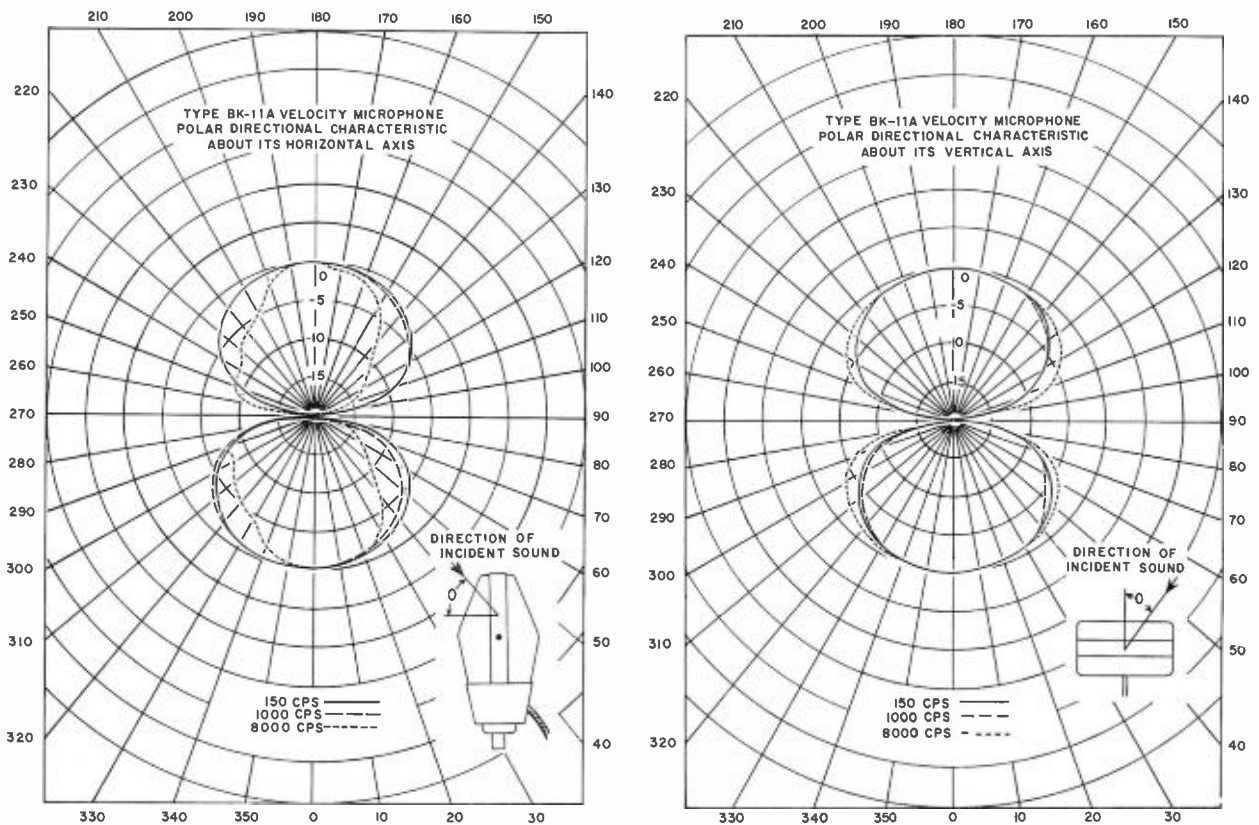
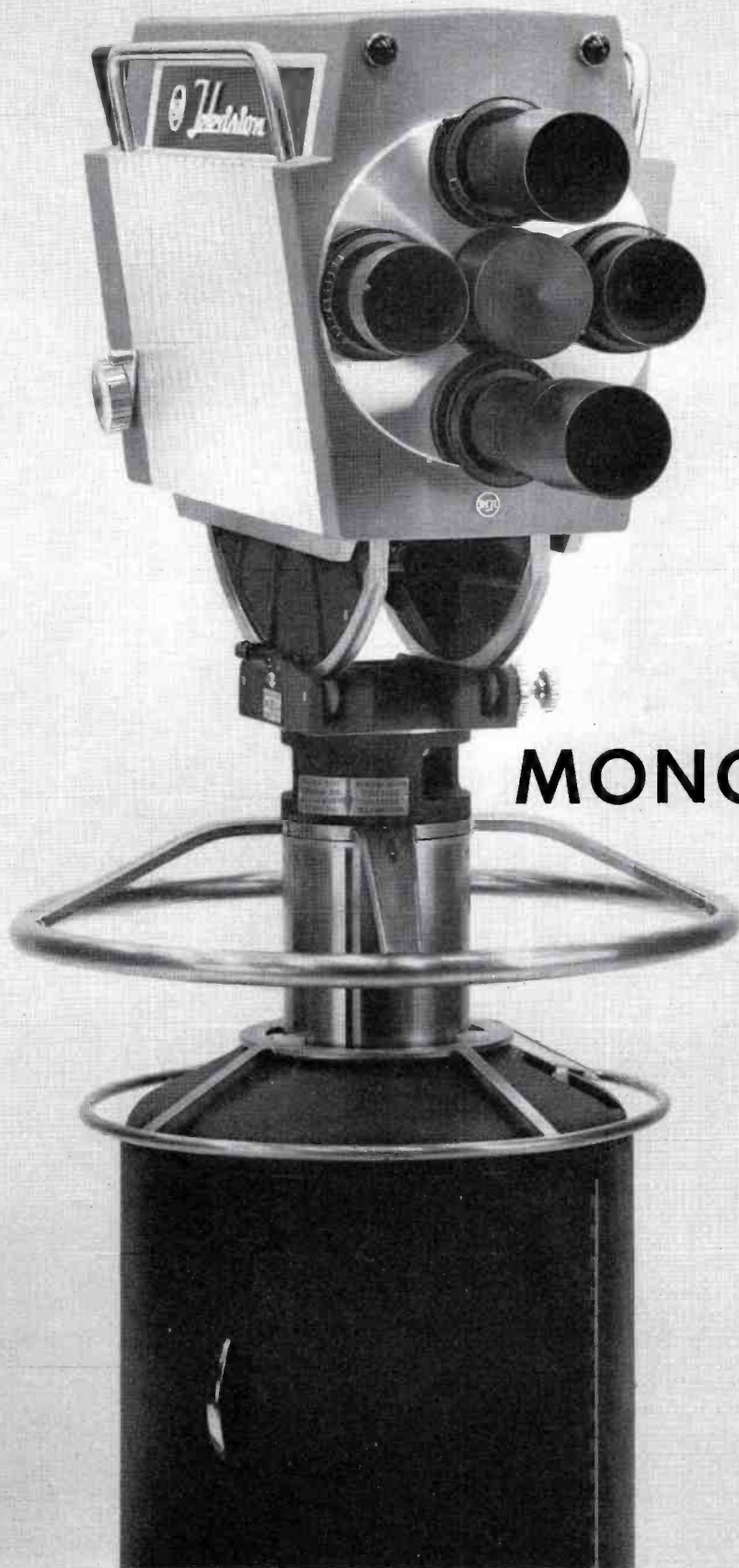

FIG. 3. Directional characteristics of the BK-11A produce figure-eight patterns in vertical and horizontal planes, thus a three-dimensional figure-eight pattern is produced.



**ALL
NEW
MONOCHROME
STUDIO
CAMERA**
type TK-12

Ultrastable New Design Uses 4½-inch Image Orthicon to Produce High-Resolution, Low-Noise Pictures; Offers Exceptional Simplicity and Economy; Employs Sleek New Styling to Complement Studio Facilities

by JOHN H. ROE, *Broadcast and Television Engineering*

The TK-12 is a monochrome studio camera, entirely new in every respect. Latest advances in operational simplicity, stability, and performance have been incorporated in its all-new design. One of its outstanding features is the use of the 4½-inch image orthicon tube (type 7389A) which is capable of producing pictures with measurably better resolution, lower noise, and improved gray scale. These qualities produce pictures which have smoothness of texture and general high quality usually associated with a good photograph.

Extensive use is made of stabilized circuitry in every part of the camera chain, beginning with the voltages applied to the image orthicon and extending through all of the video amplifiers, deflection circuits and processing circuits. As a result, a great improvement has been achieved in stability of operation, which permits in turn a major reduction in the number of operating controls and the amount of effort required for operation. The frequency with which readjustments of setup controls must be made and the amount of servicing required are also reduced significantly.

Number of Operating Controls Reduced

In the TK-12 camera chain there are only *two* operating controls. This simplification together with inherent stability makes it possible for one video operator to handle as many as six camera chains.

Favorable Characteristics of 4½-inch IO

The 4½-inch image orthicon, Type 7389A, operates on the same basic principles as the well known 3-inch types such as the 5820, 6474 and 7513. In appearance it has the same general shape, but it is simply larger in size. The significant difference from the 3-inch tubes lies in the larger area of the glass target scanned by the electron beam. It is this larger area which accounts for the ability to give increased resolution, or more significantly, increased contrast in

fine detail by a factor of almost 2 to 1. For example, measurements indicate that the signal output level of the 7389A at 400 tv lines (without aperture correction) is about 60 percent of the output at 100 tv lines. By comparison, the 400-line output of the 3-inch tube is only 30 percent.

Though the target of the 7389A is large, the photo-cathode (i.e., the used diameter) is the same as that of the 3-inch tube. Hence the *same types of camera lenses* may be used with either 4½ or 3-inch tubes. Magnification of the electron image in the 4½-inch tube is brought about by suitable strengthening and shaping of the magnetic focusing field in the image section of the tube.

Another important feature built into the 7389A is relatively close spacing between the glass target and the mesh. There are several desirable results. Signal-to-noise ratio is increased. The linear portion of the transfer characteristic is longer, permitting more accurate reproduction of the gray scale. Also, broad redistribution of second-

ary electrons is reduced, thus minimizing the characteristic overshoots and halos usually seen in pictures from the 5820. In these respects, the 7389A is similar to the 6474 and 7513 tubes. All of these characteristics, better detail and contrast, higher signal-to-noise ratio, better gray scale, and reduced overshoots and halos are important contributors to better picture quality.

To realize these improvements, it is imperative that the image orthicon has proper electrical adjustment and correct illumination or exposure. In the TK-12 camera, proper electrical adjustment (once initial adjustment has been made) is assured by a high degree of inherent circuit stability. However, the requirement for proper exposure must be satisfied by careful operation of studio lighting and of the remote iris control in the camera chain. This latter requirement is *an important area of departure from the present habitual practice with the 5820*. Optimum performance with the 7389A is achieved when *picture whites are not permitted to go more than one-half*



FIG. 1. Use of a newly developed 4½" image orthicon tube along with extremely stable circuitry produces sharp, crisp television pictures with exceptionally high resolution and low noise.

stop over the knee of the transfer characteristic. This rule means that there must be much tighter discipline over lighting in the studio by both the lighting engineer and the video control operator.

It is important to emphasize that, by virtue of the stable circuitry in the TK-12, most of the controls usually found at the console are no longer considered as operating controls. They have been eliminated

from the operating control panel, leaving *the remote iris control as the only important operating control*. This new mode of operation actually results in better picture quality and in simpler control. In fact it reduces control functions to the one which is naturally associated with camera operation, namely light control.

The 7389A image orthicon is a newly designed tube employing all of the modern

techniques of design and manufacture developed for the RCA 7513. It is made to high precision standards, and it contains the wall-mesh and high quality dynode construction which assure uniform beam landing and freedom from shading and background non-uniformities of all kinds. Close tolerances held on electrical characteristics of the RCA 7389A are a feature of special importance which permits setup controls in the TK-12 to have restricted ranges.

Description of the TK-12 Camera Chain

Integral Camera and Viewfinder

Camera and viewfinder in the TK-12 have been integrated into a single unit in contrast to the separate units in earlier TK-11/31 cameras. The streamlined styling of the new housing with its keystone motif and new lighter sage-gray coloring give it distinctive, pleasing and extremely functional appearance.

Circuit functions have been segregated into three sub-chassis and a control panel. The sub-chassis are:

- (1) Video preamplifier
- (2) Deflection amplifier and high voltage supply
- (3) Auxiliary amplifier (containing the viewfinder video amplifier, blanking signal generation, etc., and filament transformer)

The video preamplifier is located at the front of the camera at the lower left-hand side. The other two chassis are supported on opposite sides of the camera at the top. Swing-out hinges permit them to be raised for access to other parts of the camera assembly and for servicing. The control panel containing all of the setup controls for the camera chain is mounted toward the rear on the lower left side.

The image orthicon and coil assembly are on a sliding track at the bottom of the camera, slightly off center toward the right side. The viewfinder kinescope is located at the top rear of the camera. Access to all of the internal parts is provided by two side doors which hinge along the bottom, opening to horizontal positions.

The camera cable receptacle is located on the base of the camera at the rear in the

position which has become familiar in earlier RCA equipment.

The camera measures about 26 inches long, 13 $\frac{3}{4}$ inches wide (at its widest point), and 17 $\frac{3}{4}$ inches high. Approximate weight is 130 pounds.

Processing Amplifier

The processing amplifier is a rack-mounted unit built on a standard bathtub chassis occupying 15 $\frac{3}{4}$ inches of rack space. It contains all of the circuits for processing the signal delivered by the camera preamplifier and for providing three separate outputs to the signal switching and distribution system. It contains receptacles for camera cable, power input to the camera chain, and intercom and remote control circuits. Also included are a 24-volt power supply and other components required for a

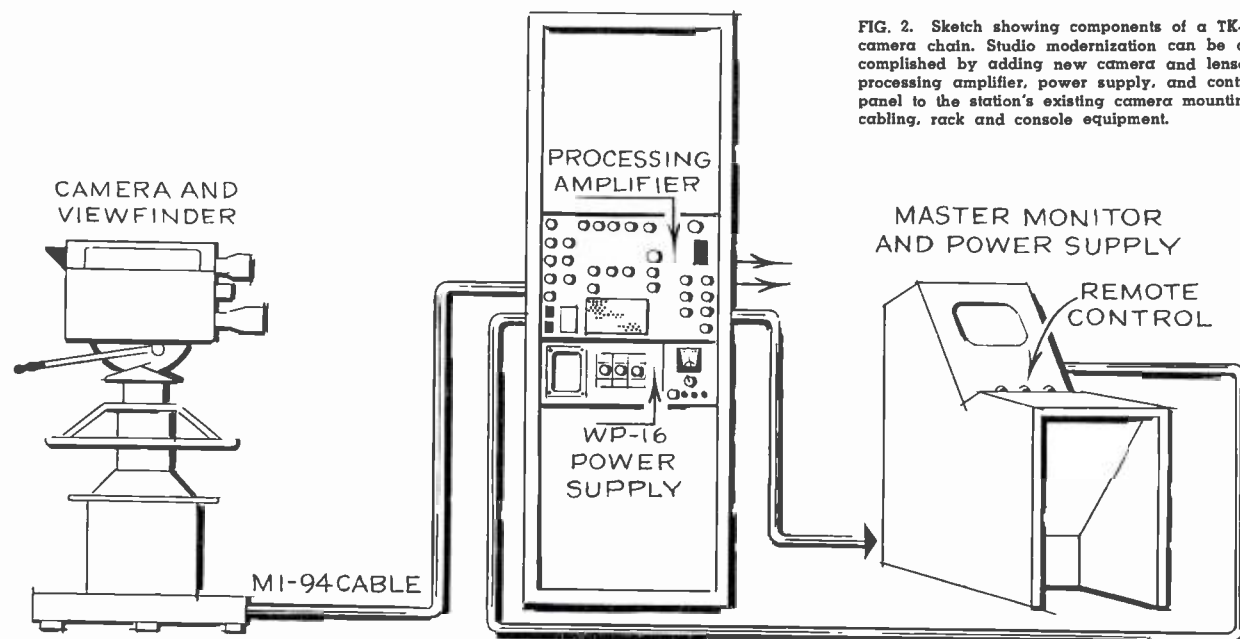

FIG. 2. Sketch showing components of a TK-12 camera chain. Studio modernization can be accomplished by adding new camera and lenses, processing amplifier, power supply, and control panel to the station's existing camera mounting, cabling, rack and console equipment.

self-contained intercom system. All controls required to set up or align the camera chain have been removed from the processing amplifier chassis.

The processing amplifier chassis may also be mounted in a suitcase for convenience in portable applications.

Remote Control Panel

The remote control panel compactly groups the two operating controls. It also includes preset gain and pedestal controls, remote lens-cap switch and tally, and an intercom phone jack and level control. This small panel may be mounted in the available space of a TM-35 Portable Master Monitor or in a suitable adaptor panel in a standard console section.

Transistorized Power Supply

A new power supply, Type WP-16, completely transistorized and with a current rating of 1.6 amperes at 280 volts, provides the necessary regulated power for the camera and processing amplifier. It also includes the necessary accessories for unregulated voltage and centering current required in the camera. Designed for rack mounting, it occupies only seven inches of rack space.

Master Monitor

In conformance with standard practice, a master monitor of the TM-6 type or equivalent is required for normal operation of the TK-12 camera chain.



FIG. 3. Camera and viewfinder have been integrated into a single unit with streamlined styling. Hinged sides provide access to setup controls and the various camera sub-chassis.

Standard Camera Cable

Because of the very extensive use of RCA MI-94 type of camera cable in nearly all television stations, it was decided to tailor the design of the TK-12 camera to the use of this same cable. Installation of the new

TK-12 camera, therefore, does not require replacement of existing cables. This is an important consideration in those cases where cables are routed through conduits in studio walls and where large quantities of MI-94 cables are already on hand.

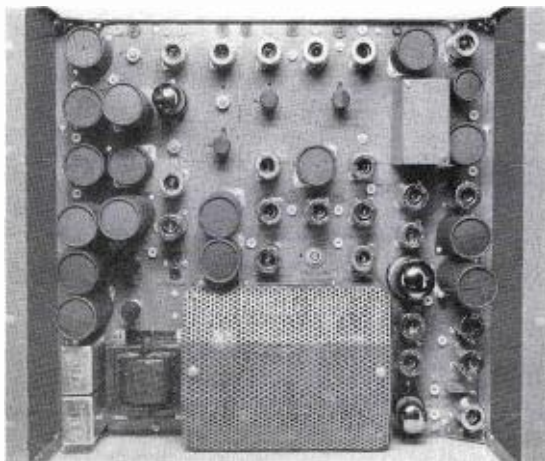

FIG. 4. The processing amplifier contains all of the circuits necessary for processing the signal delivered by the camera preamplifier and for providing three separate outputs to the signal switching and distribution system. It also contains receptacles for camera cable, power input to the camera chain and intercom and remote control circuits.



FIG. 5. This compact control panel houses the remote iris control, a combination gain and pedestal "mood effects" control, preset gain and pedestal controls, electronic lens cap switch and intercom phone jacks and level controls.



FIG. 6. Completely transistorized, the WP-16 power supply provides all power needed for operation of the camera chain.



FIG. 7. Iris control of all lenses is accomplished simultaneously by the video operator. Iris scales are linear and identical in all focal lengths.

Operational and Setup Features

The classification and location of controls in the TK-12 are directly related to the philosophy of simplified, stabilized operation. Controls are classified in two categories — operating controls and setup controls. Operating controls are those which generally require adjustment during program time to accommodate changes in lighting or scene content, or to introduce some unusual effects. Setup controls are those which affect the basic operation of tubes and circuits and which should not be used except to re-establish optimum performance if failure of some tube or other component makes replacement necessary.

Operating and Setup Controls Are Separated

The great advances in circuit stability in the TK-12 have made it possible to draw a sharp line of demarcation between operating and setup controls, whereas in earlier models of camera equipment it was necessary to include a number of setup controls along with operating controls for convenience in making relatively frequent compensations for drift. The fact that some setup controls in these earlier models were located at the console, while others were in the camera, added complications to the process of making setup adjustments. In

contrast to this situation, essentially all of the setup controls in the TK-12 equipment have been located in the camera, where the viewfinder and a built-in calibration signal provide the measuring facilities required for adjusting them, while only operating controls are placed at the console. A previously adjusted spare camera may therefore be placed into service without need for adjusting setup controls at the camera or at the control position.

All Lenses Controlled Simultaneously

The remote iris control is the principal operating control in the camera chain. An open-loop servo system drives all four lenses on the turret simultaneously. In the Taylor, Taylor, and Hobson series of lenses, the iris scales are linear and identical in all focal lengths (except in the studio Varotal zoom lens). Thus the calibrated scale at the control knob (either at the rear of the camera or at the console as determined by a selector switch) shows the actual iris setting for any lens in the standard series.

New "Mood Effects" Control

The other operating control on the remote control panel is an innovation. It is a ganged video gain-pedestal control which permits the operator to create special "mood effects" by changing pedestal setting

arbitrarily without changing peak white level. In addition to this control, two small separate controls for video gain and pedestal are also mounted at the remote control panel for presetting proper levels.

Operating Controls at the Camera

Several operating controls are located on the camera itself for the convenience of the cameraman. These include turret control, optical focusing control, and manual control for rotating a special filter wheel to place selected neutral density or other types of filters in the optical path; also two switches for reversing directions of horizontal and vertical scanning, respectively. Both the turret and focusing controls retain the general locations and modes of operation to which cameramen have become accustomed in the TK-11/31 cameras. All of the controls listed in this group are conveniently located at or near the rear of the camera.

Setup Adjustments Are Made At the Camera

Nearly all setup controls (with exception of the video gain and pedestal preset controls on the remote control panel) are found in the camera. This arrangement (once the video gain and pedestal levels have been set properly) permits a man at

the camera to perform most of the setup adjustments without the aid of an oscilloscope or a video operator.

Setup functions at the camera include the usual adjustments for the image orthicon such as beam, beam alignment, target voltage, target calibration, orthicon focus, multiplier focus, G5, G6, etc. A separate control for the wall-mesh, a new electrode in the 7389A, is also found here. Size and centering controls (dual centering controls to accommodate reversal of scanning) and linearity adjustments are located on the deflection chassis, while preset shading controls appear on the auxiliary chassis, all within the camera.

A few setup controls are necessarily parts of the processing amplifier mounted in a rack. These include the switch for adjusting cable equalization for different lengths of cable for both camera output and viewfinder input signals, the gamma selector switch, and the boost control in the aperture equalizer. These controls are usually fixed as determined by the particular installation and type of operation, and therefore are not a part of the camera setup adjustment procedure.

Built-in Calibration Signal Simplifies Signal Level Adjustments

A control for adjusting gain of the signal multiplier in the image orthicon is included among the setup controls in the camera. A built-in calibration signal is provided for making proper preset adjustment of this control. The calibration signal is a symmetrical square wave at scanning line frequency, produced by a multivibrator and shaped in a double-clipping circuit composed of precision components. A switch adds this signal to the picture signal at the input of the preamplifier.

The calibration signal is factory-adjusted to provide the normal level of 0.7 volts, peak-to-peak, at the output of the preamplifier. It presents a half-black, half-white picture on the viewfinder. By focusing the camera on a scene which is half-white, half-black, it is seen that the white portion of the image orthicon signal fills in the black area left by the calibration signal.

When the gain of the signal multiplier is correct, both halves of the scene will appear to have equal white values on the viewfinder. If they are not equal, the multiplier gain control should be adjusted to make them equal. With the stabilized circuitry in both the preamplifier and the high voltage supply, this adjustment of correct signal level should remain accurate for a considerable period of time.

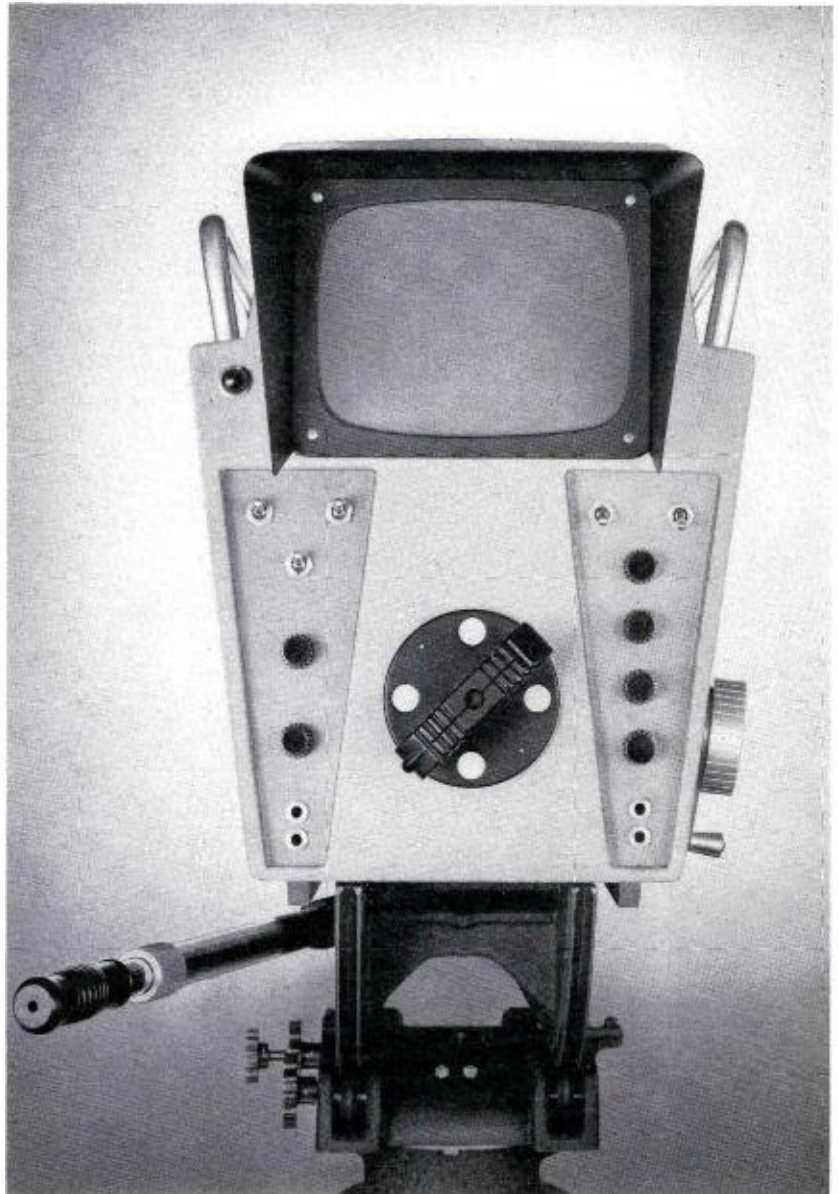

FIG. 8. The 8½" viewfinder provides large, sharp, extremely bright pictures. The maximum usable highlight brightness is at least 200 foot lamberts with center resolution of about 700 lines. These features make the viewfinder very useful as a set-up monitor as well. Composite special effects pictures can also be made available to the cameraman so that he may maneuver accordingly.

Electronic Lens Cap

A special new feature, of considerable convenience when the camera is left unattended, is an "electronic lens cap". It may be applied at any time by either the cameraman or the video operator. Tallies at both locations show when the camera has been capped. A switch cuts off the accelerating voltage in the image section of the pickup tube and applies a bias of about 4 volts to the target, thus the picture is re-

moved as effectively as if the lens were actually capped.

Built-in Orbiter

Orbiting and immobilization, completely self-contained in the camera, are provided at a speed of 1 rpm. A switch at the back of camera permits orbiting with immobilization, orbiting alone, or turning entire system off. In the "off" position, a red tally warns operator that the orbiter is not operating.

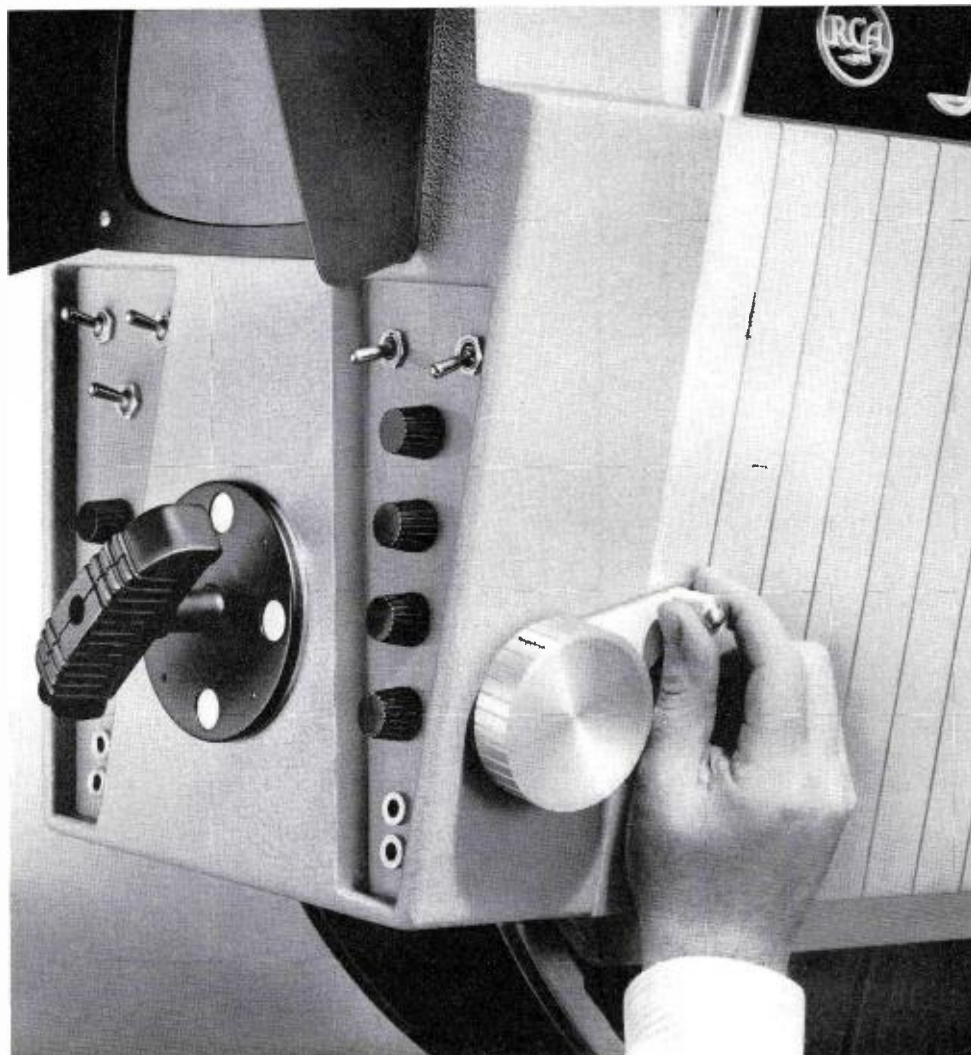

FIG. 9. Easy, accurate focus is assured by use of a counter-balanced focus mechanism. As the camera is focused, the weight of the deflection coil assembly is counterbalanced by one of the amplifier sub-assemblies within the camera.

Large, Bright Viewfinder Doubles as Setup Monitor

The viewfinder of the TK-12 has uses beyond those implied by its name. It is highly important as a monitor for making setup adjustments at the camera. Use of an 8½-inch rectangular kinescope permits a large picture, sharp and very bright. Maximum usable highlight brightness is at least 200 foot-lamberts with center resolution of about 700 lines.

The signal feed is normally from an output of the processing amplifier, permitting the cameraman to see a picture identical to that delivered to the studio output. This signal is sent over the camera cable and is equalized for flat response to the same degree as the output signal delivered by the camera.

Provision is made to select, through the studio switching system, an alternative signal to show the cameraman a composite picture from the effects system of which his picture is a part. He also has the means for selecting the output of his own preamplifier if he desires.

Counterbalanced Focus Mechanism for Ease of Focusing

A novel arrangement has been provided to counterbalance the large mass of the focus and deflection coil assembly. As the camera is focused, the weight of this assembly is counterbalanced by one of the amplifier sub-assemblies which moves in opposition to any motion of the coils. In this way, the work required to move the focus mechanism is always minimum regardless of the angle-of-tilt of the camera. Further-

more, there is no tendency for the coil assembly to "slide down hill" when the camera is tilted.

Built-in Intercom System With Amplifier And Level Controls

Each TK-12 Camera Chain includes a self-contained intercom system with its own power supply. This intercom system may be interconnected with the studio intercom, or it may be operated independently. An outstanding feature of this new intercom is the provision for transistor amplifiers at all points where headsets are plugged into the system. This permits each user to adjust sound level to suit his own needs. All stations on the intercom system have back-loading to permit the bridging of a large number without affecting sound level.

Circuit Stability is Key to Reliability and Simplicity of Operation

The fundamental basis of the TK-12's reliability and simplicity of operation is stability. A camera chain is a very complex piece of electronic equipment with a large number of variables which respond to various environmental factors and cause drift in performance. However, new developments in circuit techniques and components provide built-in immunity to, or compensation for, such drift. Therefore, excellent performance is maintained over long periods of time without readjustment of controls.

Common variations attributable to changes in temperature, line voltage, and aging of components have been "ironed out" almost completely by the use of stabilizing techniques. Simplified "no hands" operation is the result. The TK-12 will give unvarying quality in pictures hour after hour, day after day, on a simple on-off basis. Checkups on performance will be required at only rare intervals, perhaps once a week.

Controls have not been eliminated entirely; a number of "setup controls" are provided in the camera. These are needed to touch up the small variations in operating characteristics of the camera tubes, requiring serious attention only when changing image orthicons. Otherwise, they should require practically no attention. For this reason, they are located behind one of the side doors where they are not exposed to accidental or needless misadjustment.

Self-Regulating Power Transformers

All power transformers in the entire chain, including the transistorized WP-16 regulated power supply, are the self-regulating type. They permit variations in line voltage between 90 and 130 volts without any need for adjusting tap switches. This feature also provides automatic compensation for the drop in a-c supply voltage to the camera over the camera cable regardless of its length. The principal benefits from this feature, in addition to freedom from adjustment, are assurance of stabilized heater voltages on all tubes and more efficient and stable performance of regulated power supplies.

High Voltage Regulation

Close regulation of the voltages applied to the image orthicon is of prime importance in achieving stable performance. This is accomplished by using corona-discharge tubes to maintain highly accurate voltages with respect to time and on an on-off basis. In order to eliminate the possibility of even small variations of the voltages, some of

these tubes are enclosed in a temperature-controlled oven. Similar tubes are used for regulating the voltages applied to the viewfinder kinescope to assure sharp pictures of maximum brightness.

Focus Current Regulation

In addition to careful voltage regulation for the image orthicon, the magnetic focusing field must be equally stable. Current regulating circuits are employed in the processing amplifier to maintain the focus current with variations no more than about 0.12 percent. Current reference is obtained from the drop in a resistor immune to temperature variations, and voltage reference is obtained from a highly accurate zener diode.

Beam Current Stabilization

With normally-used fixed bias controls, the beam current in the image orthicon drifts through a rather large range during the first half hour or so of operation. To eliminate the need for constant resetting of this bias during warm-up, beam current stabilization is provided by the use of a high resistor in the cathode of the tube. This arrangement keeps the beam at the proper value for discharge of picture-whites and for minimum noise at all times.

Temperature Stabilization of the Image Orthicon

A separate blower is provided for temperature control of the image orthicon. This blower circulates air through the focus and deflection coil assembly. During the warm-up period, the air is heated by a thermostatically controlled heater in the outlet duct, thus permitting rapid warming. The thermostat is built into the coil assembly so

that it is in contact with the glass shoulder of the tube near the target.

Current Stabilization in Amplifier Tubes

This modern technique, which was used with great success in the color camera processing amplifier, is used almost universally in amplifier tube circuits throughout the TK-12 chain. Both temperature and aging effects which tend to cause a slump in cathode current are effectively counteracted by using a rather large cathode resistor and by providing a corresponding positive fixed bias on the grid.

Feedback Stabilization Techniques

Maximum use is made of feedback techniques in video output stages, deflection systems, and clamp circuits. These are further aids in maintaining stable signal levels, linearity, and low differential gain.

Premium Tubes

Premium tubes, with their characteristic high performance and long life, are used wherever possible. Every effort has been made to minimize the number of tube types and to operate them conservatively. Use of these tubes along with feedback and current stabilization yields a great increase in life expectancy and general reliability.

Extensive use is also made of the new, very small, Nuvistor triode tube. It is used exclusively in the video preamplifier, and in a number of other functions associated with blanking, deflection, and viewfinder amplifiers. The most significant characteristic of the Nuvistor (especially important to the video preamplifier) is freedom from microphonics. Other desirable characteristics include very small size, very low heat dissipation, high gain, and long life.

FIG. 10. Wide use has been made of premium tubes and tiny Nuvistors shown here. Nuvistors provide freedom from microphonics, have very low heat dissipation, and extremely long life.



Additional Electrical Features

Freedom From Effects of Stray Magnetic Fields

Past experience with TV cameras has shown that some stations occasionally encounter very strong magnetic fields in their studio locations. For this reason special care has been employed in the design of the TK-12 deflection assembly to provide complete magnetic shielding around the tube and its associated coils. This makes it possible to operate the camera in stray fields of intensities as high as 10 gauss without significant deterioration in picture quality.

Precision Deflection Components

Experience in the design of precision components for color cameras has brought about techniques of fabrication which have been used beneficially in the TK-12. The net result is that the deflection and focus coils will provide a degree of accuracy in

raster geometry obtainable in earlier cameras only by careful selection of coils.

Wide Bandwidth

Bandwidth of the video preamplifier and processing amplifier (including cable equalizing networks) is 10 mc within ± 1 db.

Aperture Compensation for Improved Detail Response

The signal-to-noise ratio obtainable with the 5820 image orthicon has never been considered adequate to permit the use of aperture correction. However, the improved signal-to-noise ratio obtainable with the new 4½-inch tube is good enough to permit considerable aperture correction to enhance the already improved detail response of the larger tube. Circuits for providing aperture correction are included in the processing amplifier.

Gamma Correction

The same image orthicon characteristics which permit the use of aperture correction also permit the use of a reasonable amount of gamma correction. A tap switch is included in the processing amplifier which provides three different values of gamma correction. The switch may be changed without affecting output video level.

Accurate Cable Compensation

The processing amplifier also includes a tap switch for introducing equalization for video transmission in the camera cable. This switch provides increments in compensation corresponding to 100-foot increments in length up to a maximum of 1000 feet. Compensation is accurate to 10 megacycles. The same switch assembly includes equalizing circuits for the coax used for viewfinder feed.

FIG. 11. Incorporated in the design of the all new RCA Monochrome Camera, TK-12, are startling new improvements in picture quality, significant new savings in operating costs and manpower, and new design and styling features that promise the telecaster the most modern of studio facilities.



Mechanical Features . . .

Large, Sturdy Lens Turret

The lens turret has unusually large diameter necessitated by the increased size of the image orthicon and associated deflection and focus coils. This larger diameter has several advantages. It permits greater spacing between adjacent lenses (thus reducing optical interference), more room for rugged lens mounts and the remote iris drive motor, and more rigid support of the turret by the rim bearings. The added rigidity obtained by the use of rim bearings provides for more solid mounting of heavy telephoto and zoom lenses.

Quick-Change Lens Mount

This new precision mount allows rapid change of each individual lens by means of two captive mounting screws requiring only one-half turn to clamp or to free the lens.

Adapter rings are available for those who wish to use Ektar lenses on the new TK-12. It should be noted, however, that in using these old lenses, the remote iris control feature is not available. Since light control is an important basic feature of the TK-12, the new lenses which accommodate remote iris control are recommended.

The Taylor, Taylor, Hobson Varotal zoom lens and new Series 88 Super Studio and Super Universal Zoomar lenses have provision for remote iris control and may be used on the TK-12 turret with the iris drive motor.

Wedge Mount for Camera Head

A new type of positive mount for the camera on the tilt head is provided in the form of a metal wedge and a mating wedge socket. This type of fastening permits easy and rapid mounting of the camera. Existing tilt heads may be readily adapted to the use of this new mount.

Easy-to-Service Features . . .

Many electrical and mechanical features are found in the TK-12 to facilitate servicing. The inherent stability and reliability of the circuits minimize the servicing required. When routine checking and repair are needed, a number of self-testing circuits make the job easy.

Step-by-Step Trouble Shooting

In stabilized circuits employing feedback and current stabilization, many of the normal tests for tubes and circuit performance do not give significant indications. However, an effective test of such circuits can be made by an arbitrary reduction of filament voltage. If no change in performance of the system is noted when such a reduction is made, it is an indication that the tubes are in sufficiently good condition to last for a considerable period of time. However, if there is an observable change in performance, then it becomes obvious that more detailed tests of tubes and circuits may be required to locate the trouble definitely.

In the TK-12 camera means are provided for applying this reduced voltage test to one segment of the system at a time. Thus it is possible to obtain an indication of potential trouble and to isolate it to a particular area. Test switches are included in both the camera and processing amplifier for applying this type of test in a routine manner. Whenever potential failure of tubes is indicated, the equipment involved can be placed on the list for service attention.

Pin jacks have been placed in as many positions as feasible for making either meter or oscilloscope measurements of signal and power supply voltages. These will be found very helpful in making quick checks on performance.

Swing-Out Accessibility

The focus-deflection coil assembly swings out to one side for easy replacement of image orthicon tube. This simple approach avoids removal of the turret or of any sub-

assembly within the camera. Therefore, it is possible to change the pickup tube in a period of two or three minutes.

Almost all external connections to the amplifier subassemblies of the camera are made through screw-type terminal boards. In certain cases plugs and receptacles are used. The use of terminal boards makes it relatively easy to remove a sub-assembly if necessary, and also makes it easy to check voltages and signals at terminal points. Both electrical and mechanical mountings can be easily disconnected in case it is desirable to remove a unit for servicing or replacement.

The two largest chassis subassemblies in the camera are mounted on pivots, allowing them to be turned out of the way when the side doors are opened. This provides accessibility to other areas in the camera. These subassemblies are operable in either normal or swing-out positions.

Finest Picture in Town Plus Economy

The new TK-12 Camera Chain includes a unique combination of features which promise remarkable improvement in picture quality and at the same time provide a far more simple and reliable equipment with inherent operating economy.

Use of the 4½" image orthicon tube makes possible pictures with measurably increased resolution, lower noise and better gray scale. Stabilized circuitry in every part of the camera chain beginning with the voltages applied to the image orthicon and

extending through all of the video amplifiers, deflection circuits and processing circuits, achieves a great improvement in stability of operation. This, in turn, permits a major reduction in the number of operating controls, and consequently in the amount of manpower required for operation. Further consequences of these developments are a reduction in the frequency with which readjustments of setup controls must be made and a reduction in the amount of servicing required.

Operating controls have been reduced to minimum. For the normal run of programming, the operator need only be concerned with one control, remote iris. This makes it possible for a single video operator to handle as many as six cameras.

Feature for feature, circuit for circuit, the TK-12 has been designed to provide the finest picture in town. It is the camera for the top telecasters, for those with the reputation of providing their advertisers with the very best.

AUTOMATIC SENSITIVITY CONTROL FOR MONOCHROME FILM CAMERAS

by S. L. BENDELL and K. SADASHIGE, *Broadcast and Television Equipment Engineering*

Since vidicon film cameras were first introduced for broadcast use in 1953*, they have gained wide acceptance in the television industry. The vidicon characteristics — freedom from variable shading and excellent signal-to-noise ratio — have become relatively commonplace and have been mainly responsible for the improved quality of reproduction of pictures in television film systems. The development of vidicon cameras may also be responsible for the increased emphasis on motion picture films for television programming during the past five years.

As the vidicon camera assumed its place as a standard of TV film reproduction, several new techniques were introduced to increase quality of performance in vidicon film systems. Significant among these techniques are automatic light control, automatic target control, and, most recently, automatic sensitivity control.

Constant Quality of Performance

One of the concepts introduced with the vidicon system was that of *constant quality of performance*. For example, by varying the light output from the projector, the same peak-to-peak video signal can be produced by the vidicon camera tube even though the highlight transmission of the film varies over wide limits. Thus the same high signal-to-noise ratio can always be obtained, regardless of film density.

Up to this time the operating parameters of the vidicon have been fixed and the highlight illumination on the vidicon face-plate kept constant by the use of a tapered neutral density disk between the incandescent light source and the film gate of the projector. Thus if film density increased, the neutral density disk was rotated to transmit more light from the source to the film. This was not possible with the old iconoscope cameras, because the necessary light reserve did not exist.

The concept of constant performance was preceded by a naive period in which there were hopes that films for television would be held to tight tolerances having a highlight density of 0.3 and a lowlight density



FIG. 1. Automatic sensitivity control is a 3½-inch rack mounted chassis.

of 1.8. However, broadcasters were rapidly brought to a realization that film for television often departs from these ideal figures. In fact, a typical sampling indicated that the highlight transmission of film which was expected to perform in broadcast television ranged from 80 to 3 percent transmission, depending on the type of material used. It was realistic to say that any film which was available anywhere in the stock pile would be run through a television system without regard to its characteristics, and would be called on to produce "acceptable" pictures.

After a series of tests, it was found that the most elegant method of light control was that of using a neutral density filter light control interposed between the projector lamp and the film gate. Then, it was the duty of the video operator to adjust the amount of light reaching the film so as to maintain *constant* highlight illumination on the face of the vidicon tube and thus obtain the usual 1 volt video signal level under all conditions of film density. The light control range of 100 to 1 actually took care of most violent variations in film highlight transmission characteristics.

It is apparent that neutral density disk control depends entirely on the diligence of the operator whose reaction time and attentiveness determine the quality of the final picture. Perhaps one of the most difficult transitions to handle is that from extremely dense film to a splice of extremely thin film. In this case, the amount of light which goes through thin film is sufficient to overexpose the vidicon to the extent that all information in highlights is completely washed out. Only by dropping the light intensity can the video operator regain control. His reaction time, assuming he is reasonably alert, is of the order of one or two tenths of a second. This factor, in addition to the inertia of the disk and the drive motor, sets a mini-

um limit which may approach one second of time for wide, sudden density variations.

Automatic Target Control

Even in the early stages of development it was known that the effective sensitivity of the vidicon varies directly as a power (more than square) of the target voltage. In fact, the first experimental cameras delivered to the broadcasters used manual target control as a method of providing constant signal output and constant signal-to-noise ratio. This led to experimentation with circuits to provide automatic target control. The method for carrying this out is quite straightforward. It consists of sampling the peak-to-peak video voltage with conventional detectors, passing the resultant voltage through a d-c amplifier which, in turn, varies the target voltage at the base of the load resistor in such a direction as to maintain constant video output against variations in film density.

One of the difficulties of this scheme is that the target correction voltage can be considered as a low-frequency video signal which is introduced at the base of the load resistor. Thus, any transients associated with target voltage change are fed directly into the feedback loop through the video amplifier, causing this loop to tend to oscillate. This, in turn, shows up as rather severe "bounce" transitions between scenes. The condition can be improved by lowering the loop gain or increasing the time constant of the system. Low loop gain restricts the range of operation, and a longer attack time or time constant increases the system reaction time. Experience indicates that such a system can be made to operate satisfactorily if the target control range is limited to a maximum of 10 to 1 in transmission density and if the attack-time is no shorter than two tenths of a second. Thus, if the film transitions are small and little control is required, the feedback bounce is

* H. N. Kozanowski, "Vidicon Film-Reproduction Cameras", *Journal of the SMPTE*, Vol. 62—Feb. 1954.

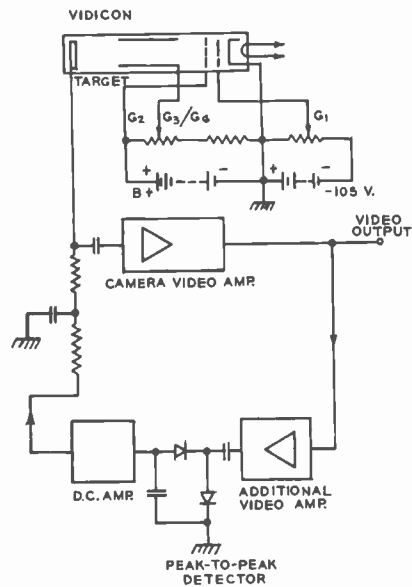

FIG. 2. Block diagram, conventional automatic target control.

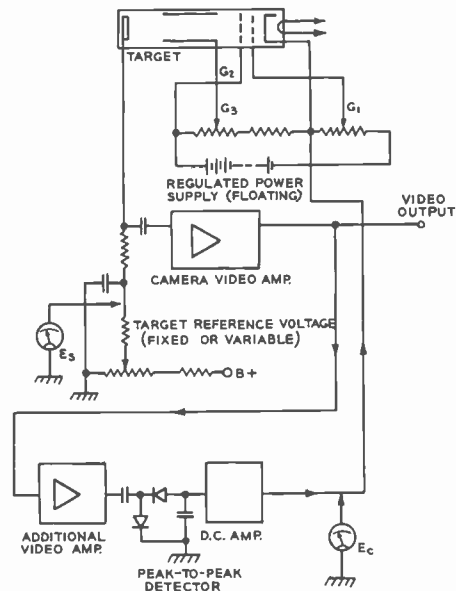

FIG. 3. Block diagram, improved automatic sensitivity control.

quite tolerable. For a large sudden transition the lost time may be as much as a second. The general arrangements of such a circuit are shown in Fig. 2.

Automatic Sensitivity Equipment

The goal of a practical system is to take care of wide transitions in highlight density which can occur at a very rapid rate, as in switching slides through a still projector. Here, the actual show time of the slide may not exceed a very few seconds, and the "lost time" during the commercial presents a very severe handicap, particularly in the transition from dense to very thin film material, since the original display of the new material is completely washed out and then recovers intelligibility as the system stabilizes. In order to improve on this, a different approach to the control of dynamic sensitivity of the vidicon is employed. A block diagram of this system is shown in Fig. 3.

In this case, the target voltage is kept at a fixed potential, the video signal output of the tube is measured to find its peak-to-peak value, this dc is passed through a d-c amplifier and now varies the potential of the cathode of the vidicon tube in accordance with the requirements of keeping output signal constant. In this way, there are no surges in the target circuit and the time-constant of the system can be made very short (less than 1/30 of a second) even

with loop gains high enough to give 100 to 1 range capability.

In order that the target sensitivity can be controlled by this means (since the vidicon sensitivity is a function of the voltage between target and cathode), all of the other electrodes are fed from a regulated power supply which actually *floats* with respect to ground and is connected to the vidicon cathode.

The reaction time of this circuit is very rapid; less than 1/2 second for a 10 to 1 change in highlight brightness. Even under the worst condition, a transition from extremely dense to very light film (100 to 1) can be accommodated in less than one second. The stability of the system is good—there is no tendency to bounce or flutter. It is important to emphasize that any automatic device of this nature can never substitute for subjective judgment of an alert operator, especially in "trick" scenes. However, the system has the virtue of always being on hand and regaining control much more rapidly than a casual operator. It should also be pointed out that there is a perceptible shift in transfer characteristic when wide ranges of density are encountered. In general, when the film density variation does not exceed 5 to 1, the amount of gamma shift is not readily perceptible to a trained operator. However, when the range approaches 100 to 1, then

the transfer characteristic becomes steeper at higher target voltages. Since the transfer characteristics of abnormally dense film are far from ideal to begin with, this shift of gamma is not a serious problem.

All-Electronic, Automatic Gain Riding Equipment

The RCA Automatic Sensitivity Control, (see Fig. 1), is rack mounted equipment developed for use with RCA TK-21C monochrome film cameras. (It can be used with earlier series TK-21 chains with simple modification.) Use of this equipment permits virtually constant video output level from the vidicon film camera. This is accomplished by applying a control voltage to the camera in order to raise or lower the sensitivity of the vidicon tube.

The principle is completely electronic; simple and fast in operation. Wide variations in highlight density which occur at a very rapid rate (as in a rapid sequence of slides) are readily handled. Recovery time with 10 to 1 change in light level is less than 1/2 second; with 100 to 1 change, less than 1 second. Change in video level is less than 5 percent with 10 to 1 change in light intensity; less than 30 percent with 100 to 1 change. The equipment, therefore, is capable of handling a wide range of variations in film density or picture highlight brightness with little or no attention from the camera operator.



Type BK-1A Pressure Microphone—High-fidelity "Commentator" pressure microphone, non-directional in character. An ideal announce mike for speakers. It assures clear, crisp speech and is well suited for remote pickup.



Type BK-5A Uniaxial Microphone with Desk Stand—Standard of the television industry, highly directional, with high front to back ratio. Unidirectional characteristic simplifies microphone and camera placement. (See boom-type below.)



Type 77-DX Polydirectional Microphone—Excellent for both voice and music. The standard of the broadcast industry. Variety of directional characteristics, with high sensitivity over entire frequency range, assures high quality reproduction.

A Microphone

Immediately Available from RCA!

Whatever your special microphone requirements, RCA can meet them exactly.

Look at the variety of models now offered. You can get pressure-type microphones—such as the BK-1A, SK-45, or BK-6B—and velocity-types—the BK-5A, 77-DX or SK-46. There are microphones for radio or TV station use; for intercom, paging, or PA use. Also mikes for announce, music, or both; for desk, boom, personal use—unidirectional, bidirectional, polydirectional.



Type BK-5A Uniaxial Microphone with Boom Mount. Specially engineered for the television industry to reduce camera noise and interference. Newly designed boom mount combines superior mechanical isolation with rugged durability. Also available with wind screen for outdoor use.

Also A Complete Line of Microphone Accessories...



TYPE "P"
MICROPHONE PLUG
MI-4630-B

CORD CONNECTOR
MI-4620-B

MICROPHONE RECEPTACLE (MALE)
MI-11087-B

TYPE "XL"
RECEPTACLE
MI-11069

MICROPHONE PLUG (MALE)
MI-11089-A

WALL RECEPTACLE
MI-4624-A

MICROPHONE RECEPTACLE (FEMALE)
MI-11088-B

MICROPHONE ADAPTORS
MI-12055

MI-12051

MI-12053



Type SK-45 Pressure Microphone—Rugged, announce microphone of the dynamic type, suitable for talk-back or cue-in purposes. Economical, light in weight, small in size. Designed for high or low impedance use.



Type BK-6B Miniature Microphone—Small but tough, this new personal microphone is easily concealed in hand or clothing. Only half the size and weight of previous models. Offers excellent speech balance when talking "off mike." Wide range frequency response.



Type SK-46 Velocity Microphone—Good low-cost studio velocity microphone for speech or music. Provides bidirectional characteristic over wide frequency range. Designed for high or low impedance use.

for Every Need...

For the finest microphones that money can buy, or for quality, low-cost, utility microphones... when you come to RCA, you know the microphone will be right—whatever the type. It has to reflect the standards for which the RCA symbol has long been famous.

... available for immediate delivery. All represent today's greatest microphone values. For information concerning any of the microphones illustrated, write today for descriptive literature. Bulletins describing desk stands, floor stands, and booms, also available.

Ask your RCA Broadcast Sales Representative



Tmk(s) ©

RADIO CORPORATION of AMERICA

BROADCAST AND TELEVISION EQUIPMENT

CAMDEN, N. J.

In Canada: RCA VICTOR Company Limited, Montreal

TT-25CL, 25-Kw Low-Band Transmitter

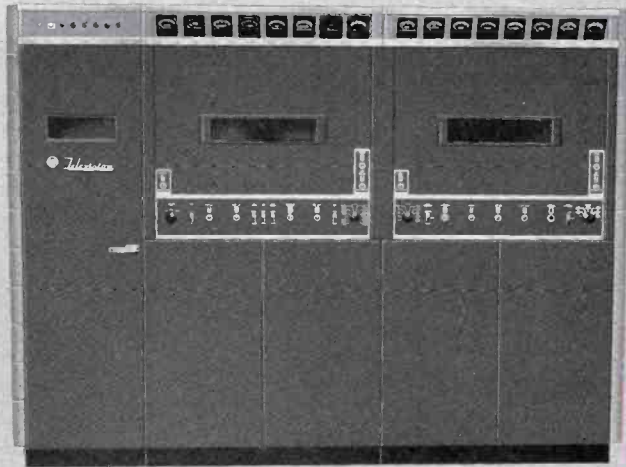

TT-6AL, 6 Kw
Low-Band
Transmitter



TT-2BL, 2 Kw Low-Band Transmitter



TTL-500AL/AH, 500-Watt Low
Power Transmitter



TTL-100AL/AH, 100-Watt Low Power
Transmitter

**Television
Transmitters
with the RCA
reputation for
Quality**

**ERP's from 100
to 5,000,000 Watts**

ANOTHER WAY RCA
SERVES INDUSTRY
THROUGH
ELECTRONICS

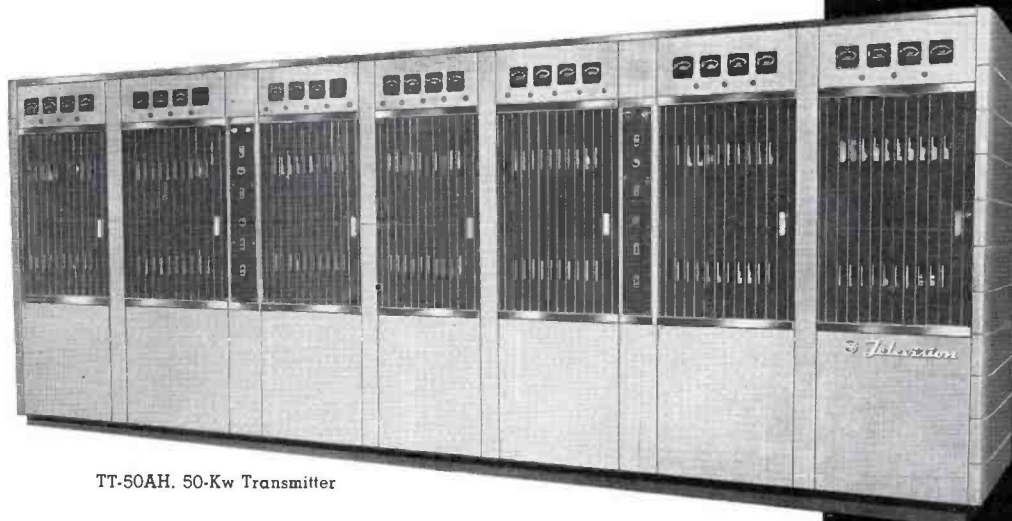

TT-50AH. 50-Kw Transmitter

Since 1929, RCA has designed and manufactured broadcast transmitters. Today, RCA offers this 30 years' experience in providing the most complete line of television transmitters ever built. Included are over 20 different TV transmitters for VHF or UHF application, at any ERP.

If you invest in an RCA television transmitter now, it will assure savings in maintenance and operating costs throughout its lifetime. Even after years of reliable operation it will still have high resale value. Since all RCA TV transmitters are now designed for color as well as monochrome, they are ready for color when you are. And most of them have provision for remote control, in anticipation of future requirements. Consider these additional advantages:

1. RCA Transmitters are generally less expensive to operate. This is true because in almost every power class RCA Transmitters use less power and have lower tube costs.
2. All are designed for color as well as monochrome.
3. All use standard tubes—easily obtainable, economical and dependable.
4. All offer excellent accessibility, reasonable installation costs; all operating controls are accessible from front panel.
5. Most use new aural and visual TV exciter to minimize intercarrier subcarrier beat during color transmission.
6. Many have built-in provisions for proposed remote control of TV transmitters.
7. In most cases, lower power units can serve as efficient drivers when you go to higher power.
8. RCA Transmitters almost always have better resale value.

For complete information about these quality transmitters, call your nearest RCA Representative. He will be glad to give you the benefit of his (and RCA's) equipment knowledge. There's no obligation. For further particulars, write to RCA, Dept. BN-107, Building 15-1, Camden, N. J. In Canada: RCA VICTOR Company Limited, Montreal.



TT-50AH. 50-Kw
VHF Power Amplifier

TT-25BL. 25-Kw
VHF Power Amplifier



Tmk(s) ®

RADIO CORPORATION of AMERICA

BROADCAST AND TELEVISION EQUIPMENT

CAMDEN, N. J.



new RCA magnetic disc recorder

combines advantages
of tape and disc!

A great new tool for broadcasters... makes
possible fast recording
and playback of
commercials
and announcements



The Magnetic Disc—
extremely rugged, not easily damaged, and with a life expectancy equal to or greater than tape. Information already recorded can be erased easily, permitting re-use of disc.

Type BQ-51A/BA-51A
Magnetic Disc Recorder and
Recording Amplifier

This new Disc Recorder, a completely self-contained unit, meets the broadcaster's requirements for fast recording and playback of commercials and announcements. Extremely simple in operation, it minimizes the skill required to produce a professional recording. Grooves for recording are molded into the blank disc. No cutting mechanisms, optical devices and heated styli are needed; the same equipment serves for recording and playback. All of the advantages of magnetic tape recording are retained in the magnetic discs, yet winding, splicing, cuing and other tape handling problems are eliminated.

A recording time of 70 seconds is obtained from each side of the magnetic disc, which includes 10 seconds for "cue-in" and "trip-out" cue tones.

The magnetic head used in the system consists of two C-shaped laminations made of a material that is extremely hard physically, but with very high permeability. A newly designed tone arm which accommodates standard MI-11874-4 (1 mil) and 11874-5 (2.5 mil) pickups also can be handled by means of a plug-in socket arrangement. It can be used for reproducing standard transcriptions and phonograph records up to 12 inches in diameter at 33 $\frac{1}{3}$ or 45 rpm.

Magnetic Recording Head.
The magnetic pole pieces which do the recording protrude through the narrow slot (see arrow).

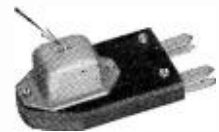

The Magnetic Disc Recorder can be the first of the building blocks in preparing for automatic programming. For complete information on the Disc Recorder and companion units call your RCA Broadcast Representative. In Canada: RCA VICTOR Company Limited, Montreal.



RADIO CORPORATION of AMERICA

BROADCAST AND TELEVISION EQUIPMENT

CAMDEN, NEW JERSEY

RCA "Traveling Wave" Antenna

ANOTHER WAY
RCA SERVES
BROADCASTERS
THROUGH
ELECTRONICS

**Combines Improved Electrical Characteristics
with Mechanical Simplicity and Economy...
for High Power TV Applications**

Here is a VHF high-band antenna that has inherently low VSWR and produces smoother patterns. The design, based on slot radiators, results in improved circularity. This new antenna is strongly resistant to high winds and offers better weather protection.

INHERENTLY LOW VSWR

The traveling wave nature of the feed results in a low VSWR along the antenna. This characteristic gives the antenna an inherently good input VSWR without compensating or matching devices. The input has been broad-banded to provide a smooth transition from the transmission line to the antenna.

EXCELLENT VERTICAL PATTERN

The null-less vertical pattern is extremely smooth. This provides uniform illumination of the desired service areas. Gains from 9 to 18 can be obtained.

IMPROVED CIRCULARITY

The individual patterns produced by slot radiators when added in phase quadrature result in an overall pattern with improved circularity. This design combines radiating elements, feed system and antenna structure in one unit, giving excellent horizontal circularity.

LOW WIND RESISTANCE

The smooth cylindrical shape of the antenna is ideal for reducing wind load and has high structural strength. It is designed to withstand a wind pressure of 50 psf on flats, or $33\frac{1}{3}$ on cylindrical surfaces. In addition, the absence of protruding elements minimizes the danger of ice damage.

The steel outer conductor is hot-dip galvanized for better conductivity and protection. The inner conductor of the antenna is rigidly supported at the bottom end without relying on any insulator type of support to carry the dead weight. Polyethylene slot covers are fastened to the pole over every slot for better weather protection.

SIMPLIFIED FEED SYSTEM

The feed system is completely self-contained with only one point of connection. Simplified feed system consists of a large coax line and coupling probes.

Your RCA Broadcast Representative will gladly help with TV antenna planning. See him for details on this new antenna. Or write to RCA, Dept. BC-22, Building 15-1, Camden, N. J. In Canada: RCA VICTOR Company Limited, Montreal.

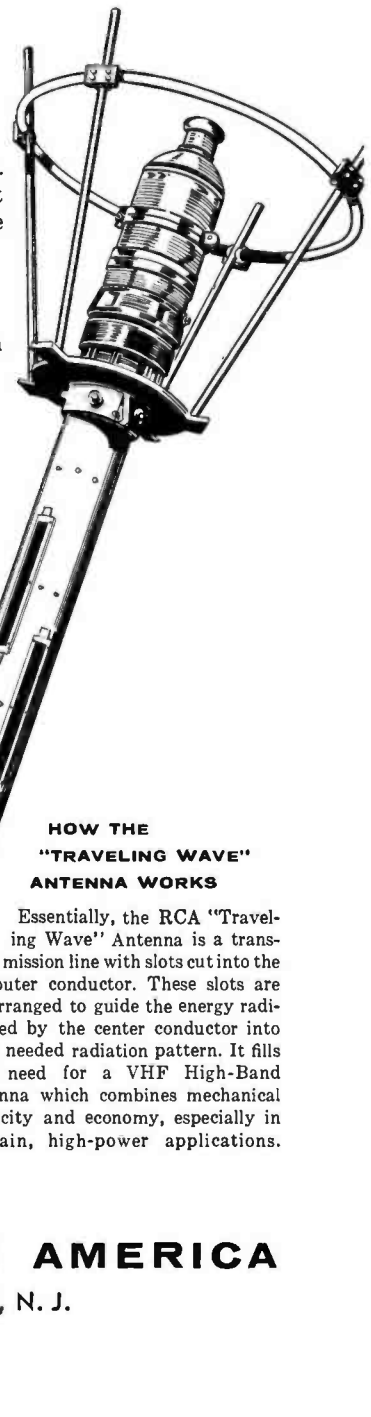

HOW THE "TRAVELING WAVE" ANTENNA WORKS

Essentially, the RCA "Traveling Wave" Antenna is a transmission line with slots cut into the outer conductor. These slots are arranged to guide the energy radiated by the center conductor into the needed radiation pattern. It fills the need for a VHF High-Band Antenna which combines mechanical simplicity and economy, especially in high-gain, high-power applications.



Tmk(s) ©

RADIO CORPORATION of AMERICA
BROADCAST AND TELEVISION EQUIPMENT, CAMDEN, N. J.



Tape Footage Indicator

Electronic Quadrature Control



Magnetic Tone Wheel



Variable Speed Cuing Control



Master Erase Head

Built-in Picture Monitor

GET ALL THE LIVING COLOR DETAIL ...WITH RCA EQUIPMENT

Color has sell! Color demands attention! By standardizing on RCA color tv equipment you get all the picture freshness, all the living color detail! From color camera to tv tape recorder to transmitter, you can depend on RCA's distinguished line of color television equipment—all with built-in quality control features—to assure maximum color performance . . . The RCA advanced TV Tape Recorder has

the features that mean color quality, including *electronic quadrature adjustment, sync regeneration, four-channel playback equalization and built-in test equipment.* And the RCA precision color television camera provides superb resolving power; clear, precise matching of colors—thanks to new precision yokes and prism optics . . . *Why settle for less than the best?* See your RCA representative.

FOR COLOR AT ITS BEST
MAKE IT...RCA ALL THE WAY



RADIO CORPORATION of AMERICA

BROADCAST AND TELEVISION EQUIPMENT

CAMDEN, N. J.